

**SECTION LAN**  
**LAN SYSTEM**

A  
B  
C

**CONTENTS**

D  
E

|   |           |  |           |            |
|---|-----------|--|-----------|------------|
| <b>CAN FUNDAMENTAL</b>                                      |           | <b>PRECAUTIONS</b> .....   | <b>21</b> | <b>F</b>   |
| <b>PRECAUTION</b> .....                                     | <b>5</b>  | Precaution for Supplemental Restraint System (SRS) "AIR BAG" and "SEAT BELT PRE-TENSIONER" ..... | <b>21</b> | <b>G</b>   |
| <b>PRECAUTIONS</b> .....                                    | <b>5</b>  | Precautions for Trouble Diagnosis .....  | <b>21</b> |            |
| Precautions for Trouble Diagnosis .....                     | <b>5</b>  | Precautions for Harness Repair .....   | <b>21</b> |            |
| Precautions for Harness Repair .....                        | <b>5</b>  | <b>BASIC INSPECTION</b> .....  | <b>23</b> | <b>H</b>   |
| <b>SYSTEM DESCRIPTION</b> .....                             | <b>6</b>  | <b>DIAGNOSIS AND REPAIR WORKFLOW</b> .....   | <b>23</b> | <b>I</b>   |
| <b>CAN COMMUNICATION SYSTEM</b> .....                       | <b>6</b>  | Interview Sheet .....  | <b>23</b> |            |
| System Description .....                                    | <b>6</b>  | <b>SYSTEM DESCRIPTION</b> .....  | <b>24</b> |            |
| System Diagram .....  | <b>6</b>  | <b>CAN COMMUNICATION SYSTEM</b> .....  | <b>24</b> | <b>J</b>   |
| CAN Communication Control Circuit .....                     | <b>7</b>  | CAN System Specification Chart .....   | <b>24</b> |            |
| <b>DIAG ON CAN</b> .....                                    | <b>8</b>  | CAN Communication Signal Chart .....   | <b>24</b> | <b>K</b>   |
| Description .....   | <b>8</b>  | <b>WIRING DIAGRAM</b> .....  | <b>28</b> |            |
| System Diagram .....  | <b>8</b>  | <b>CAN SYSTEM</b> .....  | <b>28</b> | <b>L</b>   |
| <b>TROUBLE DIAGNOSIS</b> .....                              | <b>9</b>  | Wiring Diagram .....   | <b>28</b> |            |
| Condition of Error Detection .....                          | <b>9</b>  | <b>DTC/CIRCUIT DIAGNOSIS</b> .....   | <b>36</b> |            |
| Symptom When Error Occurs in CAN Communication System ..... | <b>9</b>  | <b>CAN COMMUNICATION SYSTEM</b> .....  | <b>36</b> | <b>LAN</b> |
| CAN Diagnosis with CONSULT .....                            | <b>12</b> | Component Parts Location .....   | <b>36</b> |            |
| Self-Diagnosis .....  | <b>12</b> | <b>MALFUNCTION AREA CHART</b> .....  | <b>37</b> | <b>N</b>   |
| CAN Diagnostic Support Monitor .....                        | <b>12</b> | Main Line .....  | <b>37</b> |            |
| How to Use CAN Communication Signal Chart .....             | <b>14</b> | Branch Line .....  | <b>37</b> | <b>O</b>   |
| <b>BASIC INSPECTION</b> .....                               | <b>15</b> | Short Circuit .....  | <b>37</b> |            |
| <b>DIAGNOSIS AND REPAIR WORKFLOW</b> .....                  | <b>15</b> | <b>MAIN LINE BETWEEN ADP AND DLC CIRCUIT</b> .....   | <b>38</b> | <b>P</b>   |
| Trouble Diagnosis Flow Chart .....                          | <b>15</b> | Diagnosis Procedure .....  | <b>38</b> |            |
| Trouble Diagnosis Procedure .....                           | <b>15</b> | <b>MAIN LINE BETWEEN DLC AND HVAC CIRCUIT</b> .....  | <b>39</b> |            |
| <b>CAN</b>  |           | Diagnosis Procedure .....  | <b>39</b> |            |
| <b>HOW TO USE THIS MANUAL</b> .....                         | <b>20</b> | <b>MAIN LINE BETWEEN HVAC AND ABS CIRCUIT</b> .....  | <b>40</b> |            |
| <b>HOW TO USE THIS SECTION</b> .....                        | <b>20</b> |  |           |            |
| Caution .....   | <b>20</b> |  |           |            |
| Abbreviation List .....                                     | <b>20</b> |  |           |            |
| <b>PRECAUTION</b> .....                                     | <b>21</b> |  |           |            |

|   |           |   |           |
|---|-----------|---|-----------|
| Diagnosis Procedure .....                                 | 40        | <b>ECM BRANCH LINE CIRCUIT .....</b>                      | <b>60</b> |
|   |           | Diagnosis Procedure .....                                 | 60        |
| <b>MAIN LINE BETWEEN HVAC AND A-BAG<br/>CIRCUIT .....</b> | <b>41</b> | <b>BCM BRANCH LINE CIRCUIT .....</b>                      | <b>61</b> |
| Diagnosis Procedure .....                                 | 41        | Diagnosis Procedure .....                                 | 61        |
| <b>MAIN LINE BETWEEN A-BAG AND ABS<br/>CIRCUIT .....</b>  | <b>42</b> | <b>DLC BRANCH LINE CIRCUIT .....</b>                      | <b>62</b> |
| Diagnosis Procedure .....                                 | 42        | Diagnosis Procedure .....                                 | 62        |
| <b>ECM BRANCH LINE CIRCUIT .....</b>                      | <b>43</b> | <b>M&amp;A BRANCH LINE CIRCUIT .....</b>                  | <b>63</b> |
| Diagnosis Procedure .....                                 | 43        | Diagnosis Procedure .....                                 | 63        |
| <b>ADP BRANCH LINE CIRCUIT .....</b>                      | <b>44</b> | <b>HVAC BRANCH LINE CIRCUIT .....</b>                     | <b>64</b> |
| Diagnosis Procedure .....                                 | 44        | Diagnosis Procedure .....                                 | 64        |
| <b>BCM BRANCH LINE CIRCUIT .....</b>                      | <b>45</b> | <b>STRG BRANCH LINE CIRCUIT .....</b>                     | <b>65</b> |
| Diagnosis Procedure .....                                 | 45        | Diagnosis Procedure .....                                 | 65        |
| <b>DLC BRANCH LINE CIRCUIT .....</b>                      | <b>46</b> | <b>A-BAG BRANCH LINE CIRCUIT .....</b>                    | <b>66</b> |
| Diagnosis Procedure .....                                 | 46        | Diagnosis Procedure .....                                 | 66        |
| <b>M&amp;A BRANCH LINE CIRCUIT .....</b>                  | <b>47</b> | <b>ABS BRANCH LINE CIRCUIT .....</b>                      | <b>67</b> |
| Diagnosis Procedure .....                                 | 47        | Diagnosis Procedure .....                                 | 67        |
| <b>AV BRANCH LINE CIRCUIT .....</b>                       | <b>48</b> | <b>TCM BRANCH LINE CIRCUIT .....</b>                      | <b>68</b> |
| Diagnosis Procedure .....                                 | 48        | Diagnosis Procedure .....                                 | 68        |
| <b>HVAC BRANCH LINE CIRCUIT .....</b>                     | <b>49</b> | <b>IPDM-E BRANCH LINE CIRCUIT .....</b>                   | <b>69</b> |
| Diagnosis Procedure .....                                 | 49        | Diagnosis Procedure .....                                 | 69        |
| <b>STRG BRANCH LINE CIRCUIT .....</b>                     | <b>50</b> | <b>CAN COMMUNICATION CIRCUIT .....</b>                    | <b>70</b> |
| Diagnosis Procedure .....                                 | 50        | Diagnosis Procedure .....                                 | 70        |
| <b>A-BAG BRANCH LINE CIRCUIT .....</b>                    | <b>51</b> | <b>CAN SYSTEM (TYPE 3)</b>                                |           |
| Diagnosis Procedure .....                                 | 51        | <b>DTC/CIRCUIT DIAGNOSIS .....</b>                        | <b>72</b> |
| <b>ABS BRANCH LINE CIRCUIT .....</b>                      | <b>52</b> | <b>MAIN LINE BETWEEN DLC AND HVAC CIR-<br/>CUIT .....</b> | <b>72</b> |
| Diagnosis Procedure .....                                 | 52        | Diagnosis Procedure .....                                 | 72        |
| <b>TCM BRANCH LINE CIRCUIT .....</b>                      | <b>53</b> | <b>MAIN LINE BETWEEN HVAC AND A-BAG<br/>CIRCUIT .....</b> | <b>73</b> |
| Diagnosis Procedure .....                                 | 53        | Diagnosis Procedure .....                                 | 73        |
| <b>IPDM-E BRANCH LINE CIRCUIT .....</b>                   | <b>54</b> | <b>MAIN LINE BETWEEN A-BAG AND ABS<br/>CIRCUIT .....</b>  | <b>74</b> |
| Diagnosis Procedure .....                                 | 54        | Diagnosis Procedure .....                                 | 74        |
| <b>CAN COMMUNICATION CIRCUIT .....</b>                    | <b>55</b> | <b>ECM BRANCH LINE CIRCUIT .....</b>                      | <b>75</b> |
| Diagnosis Procedure .....                                 | 55        | Diagnosis Procedure .....                                 | 75        |
| <b>CAN SYSTEM (TYPE 1)</b>                                |           | <b>BCM BRANCH LINE CIRCUIT .....</b>                      | <b>76</b> |
| <b>DTC/CIRCUIT DIAGNOSIS .....</b>                        | <b>57</b> | Diagnosis Procedure .....                                 | 76        |
| <b>MAIN LINE BETWEEN DLC AND HVAC CIR-<br/>CUIT .....</b> | <b>57</b> | <b>DLC BRANCH LINE CIRCUIT .....</b>                      | <b>77</b> |
| Diagnosis Procedure .....                                 | 57        | Diagnosis Procedure .....                                 | 77        |
| <b>MAIN LINE BETWEEN HVAC AND A-BAG<br/>CIRCUIT .....</b> | <b>58</b> | <b>M&amp;A BRANCH LINE CIRCUIT .....</b>                  | <b>78</b> |
| Diagnosis Procedure .....                                 | 58        | Diagnosis Procedure .....                                 | 78        |
| <b>MAIN LINE BETWEEN A-BAG AND ABS<br/>CIRCUIT .....</b>  | <b>59</b> | <b>AV BRANCH LINE CIRCUIT .....</b>                       | <b>79</b> |
| Diagnosis Procedure .....                                 | 59        | Diagnosis Procedure .....                                 | 79        |

|  |           |  |            |
|--|-----------|--|------------|
| <b>HVAC BRANCH LINE CIRCUIT</b> .....      | <b>80</b> | <b>A-BAG BRANCH LINE CIRCUIT</b> .....     | <b>100</b> |
| Diagnosis Procedure .....                  | 80        | Diagnosis Procedure .....                  | 100        |
| <b>STRG BRANCH LINE CIRCUIT</b> .....      | <b>81</b> | <b>ABS BRANCH LINE CIRCUIT</b> .....       | <b>101</b> |
| Diagnosis Procedure .....                  | 81        | Diagnosis Procedure .....                  | 101        |
| <b>A-BAG BRANCH LINE CIRCUIT</b> .....     | <b>82</b> | <b>TCM BRANCH LINE CIRCUIT</b> .....       | <b>102</b> |
| Diagnosis Procedure .....                  | 82        | Diagnosis Procedure .....                  | 102        |
| <b>ABS BRANCH LINE CIRCUIT</b> .....       | <b>83</b> | <b>IPDM-E BRANCH LINE CIRCUIT</b> .....    | <b>103</b> |
| Diagnosis Procedure .....                  | 83        | Diagnosis Procedure .....                  | 103        |
| <b>TCM BRANCH LINE CIRCUIT</b> .....       | <b>84</b> | <b>CAN COMMUNICATION CIRCUIT</b> .....     | <b>104</b> |
| Diagnosis Procedure .....                  | 84        | Diagnosis Procedure .....                  | 104        |
| <b>IPDM-E BRANCH LINE CIRCUIT</b> .....    | <b>85</b> | <b>CAN SYSTEM (TYPE 5)</b>                 |            |
| Diagnosis Procedure .....                  | 85        | <b>DTC/CIRCUIT DIAGNOSIS</b> .....         | <b>106</b> |
| <b>CAN COMMUNICATION CIRCUIT</b> .....     | <b>86</b> | <b>MAIN LINE BETWEEN ADP AND DLC CIR-</b>  |            |
| Diagnosis Procedure .....                  | 86        | <b>CUIT</b> .....                          | <b>106</b> |
| <b>CAN SYSTEM (TYPE 4)</b>                 |           | Diagnosis Procedure .....                  | 106        |
| <b>DTC/CIRCUIT DIAGNOSIS</b> .....         | <b>88</b> | <b>MAIN LINE BETWEEN DLC AND HVAC CIR-</b> |            |
| <b>MAIN LINE BETWEEN ADP AND DLC CIR-</b>  |           | <b>CUIT</b> .....                          | <b>107</b> |
| <b>CUIT</b> .....                          | <b>88</b> | Diagnosis Procedure .....                  | 107        |
| Diagnosis Procedure .....                  | 88        | <b>MAIN LINE BETWEEN HVAC AND ABS CIR-</b> |            |
| <b>MAIN LINE BETWEEN DLC AND HVAC CIR-</b> |           | <b>CUIT</b> .....                          | <b>108</b> |
| <b>CUIT</b> .....                          | <b>89</b> | Diagnosis Procedure .....                  | 108        |
| Diagnosis Procedure .....                  | 89        | <b>ECM BRANCH LINE CIRCUIT</b> .....       | <b>109</b> |
| <b>MAIN LINE BETWEEN HVAC AND A-BAG</b>    |           | Diagnosis Procedure .....                  | 109        |
| <b>CIRCUIT</b> .....                       | <b>90</b> | <b>ADP BRANCH LINE CIRCUIT</b> .....       | <b>110</b> |
| Diagnosis Procedure .....                  | 90        | Diagnosis Procedure .....                  | 110        |
| <b>MAIN LINE BETWEEN A-BAG AND ABS</b>     |           | <b>BCM BRANCH LINE CIRCUIT</b> .....       | <b>111</b> |
| <b>CIRCUIT</b> .....                       | <b>91</b> | Diagnosis Procedure .....                  | 111        |
| Diagnosis Procedure .....                  | 91        | <b>DLC BRANCH LINE CIRCUIT</b> .....       | <b>112</b> |
| <b>ECM BRANCH LINE CIRCUIT</b> .....       | <b>92</b> | Diagnosis Procedure .....                  | 112        |
| Diagnosis Procedure .....                  | 92        | <b>M&amp;A BRANCH LINE CIRCUIT</b> .....   | <b>113</b> |
| <b>ADP BRANCH LINE CIRCUIT</b> .....       | <b>93</b> | Diagnosis Procedure .....                  | 113        |
| Diagnosis Procedure .....                  | 93        | <b>AV BRANCH LINE CIRCUIT</b> .....        | <b>114</b> |
| <b>BCM BRANCH LINE CIRCUIT</b> .....       | <b>94</b> | Diagnosis Procedure .....                  | 114        |
| Diagnosis Procedure .....                  | 94        | <b>HVAC BRANCH LINE CIRCUIT</b> .....      | <b>115</b> |
| <b>DLC BRANCH LINE CIRCUIT</b> .....       | <b>95</b> | Diagnosis Procedure .....                  | 115        |
| Diagnosis Procedure .....                  | 95        | <b>STRG BRANCH LINE CIRCUIT</b> .....      | <b>116</b> |
| <b>M&amp;A BRANCH LINE CIRCUIT</b> .....   | <b>96</b> | Diagnosis Procedure .....                  | 116        |
| Diagnosis Procedure .....                  | 96        | <b>ABS BRANCH LINE CIRCUIT</b> .....       | <b>117</b> |
| <b>AV BRANCH LINE CIRCUIT</b> .....        | <b>97</b> | Diagnosis Procedure .....                  | 117        |
| Diagnosis Procedure .....                  | 97        | <b>TCM BRANCH LINE CIRCUIT</b> .....       | <b>118</b> |
| <b>HVAC BRANCH LINE CIRCUIT</b> .....      | <b>98</b> | Diagnosis Procedure .....                  | 118        |
| Diagnosis Procedure .....                  | 98        | <b>IPDM-E BRANCH LINE CIRCUIT</b> .....    | <b>119</b> |
| <b>STRG BRANCH LINE CIRCUIT</b> .....      | <b>99</b> | Diagnosis Procedure .....                  | 119        |
| Diagnosis Procedure .....                  | 99        |  |            |

A  
B  
C  
D  
E  
F  
G  
H  
I  
J  
K  
L  
N  
O  
P

LAN



PRECAUTION

PRECAUTIONS

Precautions for Trouble Diagnosis

INFOID:000000008634470

**CAUTION:**

- Never apply 7.0 V or more to the measurement terminal.
- Use a tester with open terminal voltage of 7.0 V or less.
- Turn the ignition switch OFF and disconnect the battery cable from the negative terminal when checking the harness.

Precautions for Harness Repair

INFOID:000000008634471

- Solder the repaired area and wrap tape around the soldered area.

**NOTE:**

A fray of twisted lines must be within 110 mm (4.33 in).

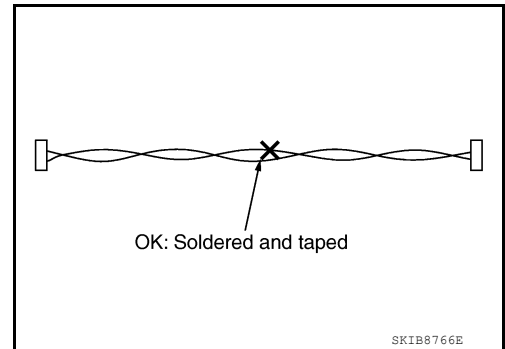

- Bypass connection is never allowed at the repaired area.

**NOTE:**

Bypass connection may cause CAN communication error. The spliced wire becomes separated and the characteristics of twisted line are lost.

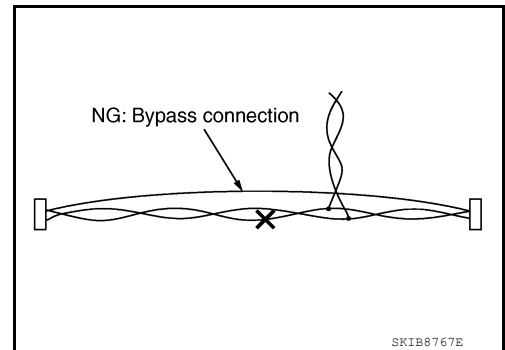

- Replace the applicable harness as an assembly if error is detected on the shield lines of CAN communication line.

A  
B  
C  
D  
E  
F  
G  
H  
I  
J  
K  
L

LAN

## SYSTEM DESCRIPTION

### CAN COMMUNICATION SYSTEM

#### System Description

INFOID:000000008634472

- CAN communication is a multiplex communication system. This enables the system to transmit and receive large quantities of data at high speed by connecting control units with two communication lines (CAN-H and CAN-L).
- Control units on the CAN network transmit signals using the CAN communication control circuit. They receive only necessary signals from other control units to operate various functions.
- CAN communication lines adopt twisted-pair line style (two lines twisted) for noise immunity.

#### System Diagram

INFOID:000000008634473

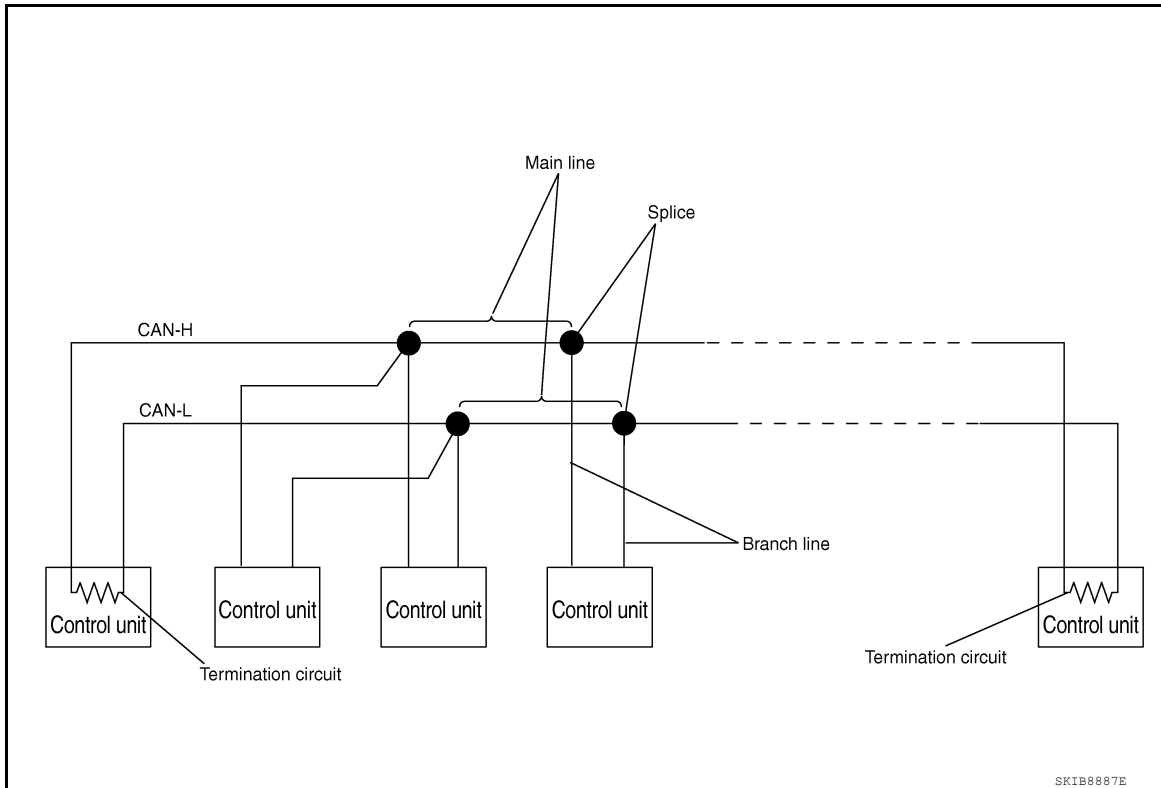

Each control unit passes an electric current to the termination circuits when transmitting CAN communication signal. The termination circuits produce an electrical potential difference between CAN-H and CAN-L. CAN communication system transmits and receives CAN communication signals by the potential difference.

| Component           | Description   |
|---------------------|---|
| Main line           | CAN communication line between splices                                |
| Branch line         | CAN communication line between splice and a control unit              |
| Splice              | A point connecting a branch line with a main line                     |
| Termination circuit | Refer to <a href="#">LAN-7, "CAN Communication Control Circuit"</a> . |

# CAN COMMUNICATION SYSTEM

< SYSTEM DESCRIPTION >

[CAN FUNDAMENTAL]

## CAN Communication Control Circuit

INFOID:000000008634474

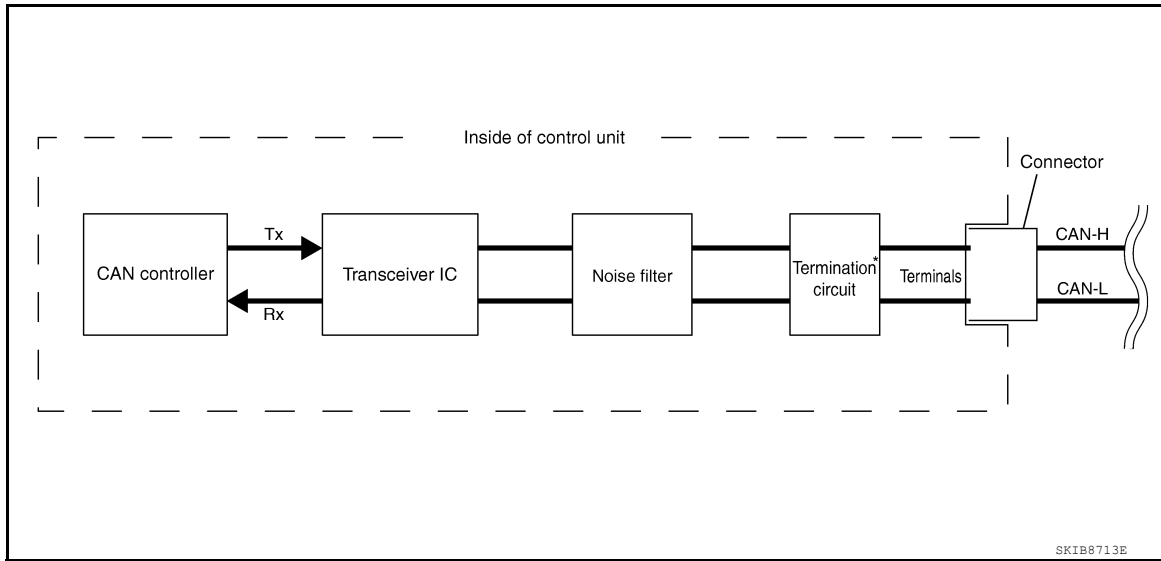

| Component   | System description  |
|---|---|
| CAN controller  | It controls CAN communication signal transmission and reception, error detection, etc.                      |
| Transceiver IC  | It converts digital signal into CAN communication signal, and CAN communication signal into digital signal. |
| Noise filter  | It eliminates noise of CAN communication signal.  |
| Termination circuit*<br>(Resistance of approx. 120 Ω) | It produces potential difference.   |

\*: These are the only control units wired with both ends of CAN communication system.

A  
B  
C  
D  
E  
F  
G  
H  
I  
J  
K  
L

LAN

## DIAG ON CAN

### Description

INFOID:000000008634475

“Diag on CAN” is a diagnosis using CAN communication instead of previous DDL1 and DDL2 communication lines, between control units and diagnosis unit.

### System Diagram

INFOID:000000008634476

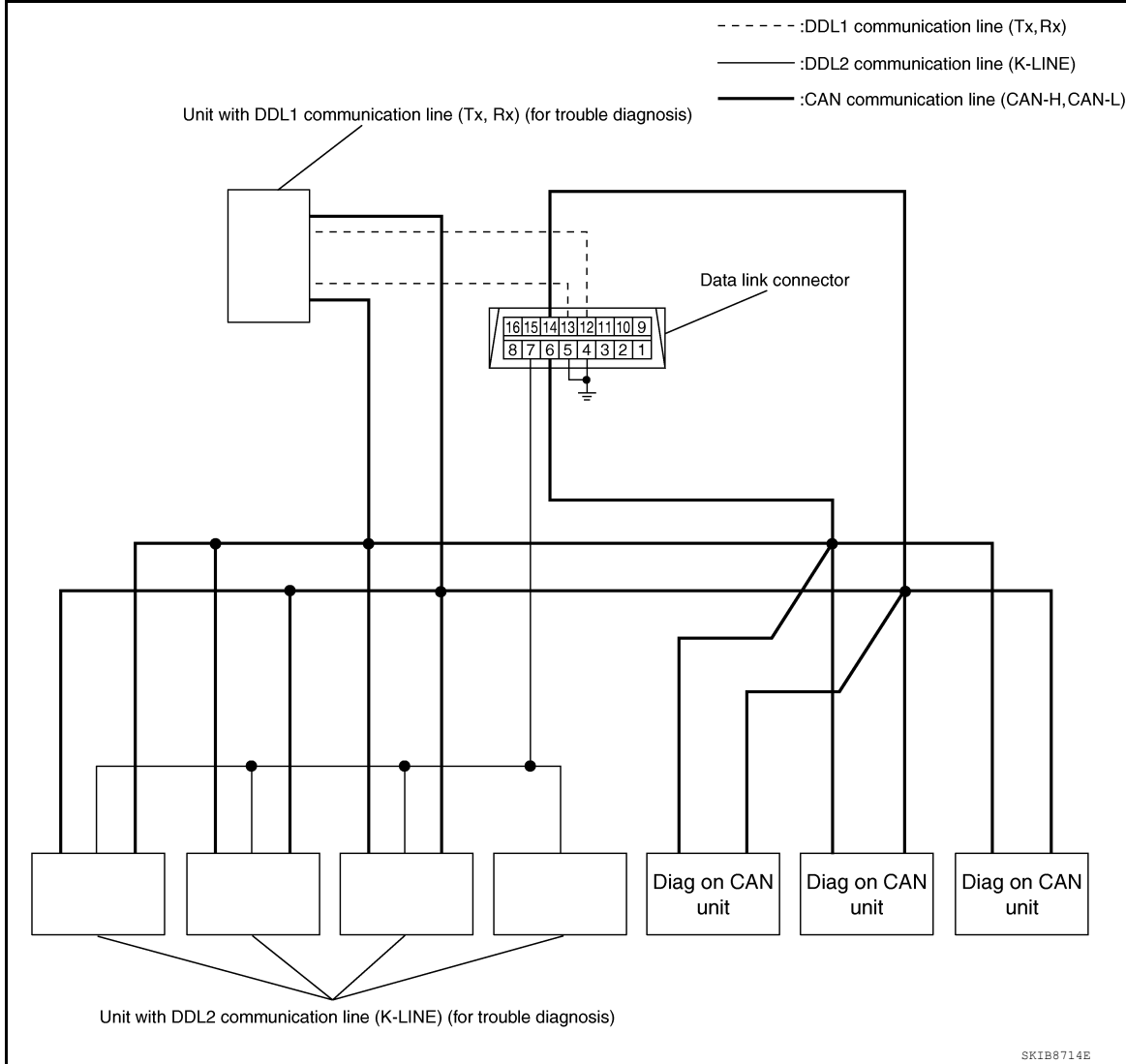

| Name        | Harness        | Description  |
|-------------|----------------|--|
| DDL1        | Tx<br>Rx       | It is used for trouble diagnosis. (CAN-H and CAN-L are used for controlling) |
| DDL2        | K-LINE         | It is used for trouble diagnosis. (CAN-H and CAN-L are used for controlling) |
| Diag on CAN | CAN-H<br>CAN-L | It is used for trouble diagnosis and control.                                |



## TROUBLE DIAGNOSIS

### Condition of Error Detection

INFOID:000000008634477

DTC (e.g. U1000 and U1001) of CAN communication is indicated on SELF-DIAG RESULTS on CONSULT if a CAN communication signal is not transmitted or received between units for 2 seconds or more.

#### CAN COMMUNICATION SYSTEM ERROR

- CAN communication line open (CAN-H, CAN-L, or both)
- CAN communication line short (ground, between CAN communication lines, other harnesses)
- Error of CAN communication control circuit of the unit connected to CAN communication line

#### WHEN DTC OF CAN COMMUNICATION IS INDICATED EVEN THOUGH CAN COMMUNICATION SYSTEM IS NORMAL

- Removal/installation of parts: Error may be detected when removing and installing CAN communication unit and related parts while turning the ignition switch ON. (A DTC except for CAN communication may be detected.)
- Fuse blown out (removed): CAN communication of the unit may cease.
- Voltage drop: Error may be detected if voltage drops due to discharged battery when turning the ignition switch ON (Depending on the control unit which carries out CAN communication).
- Error may be detected if the power supply circuit of the control unit, which carries out CAN communication, malfunctions (Depending on the control unit which carries out CAN communication).
- Error may be detected if reprogramming is not completed normally.

**CAUTION:**

**CAN communication system is normal if DTC of CAN communication is indicated on SELF-DIAG RESULTS of CONSULT under the above conditions. Erase the memory of the self-diagnosis of each unit.**

### Symptom When Error Occurs in CAN Communication System

INFOID:000000008634478

In CAN communication system, multiple units mutually transmit and receive signals. Each unit cannot transmit and receive signals if any error occurs on CAN communication line. Under this condition, multiple control units related to the root cause malfunction or go into fail-safe mode.

#### ERROR EXAMPLE

**NOTE:**

- Each vehicle differs in symptom of each unit under fail-safe mode and CAN communication line wiring.
- Refer to [LAN-20, "Abbreviation List"](#) for the unit abbreviation.

Example: TCM branch line open circuit

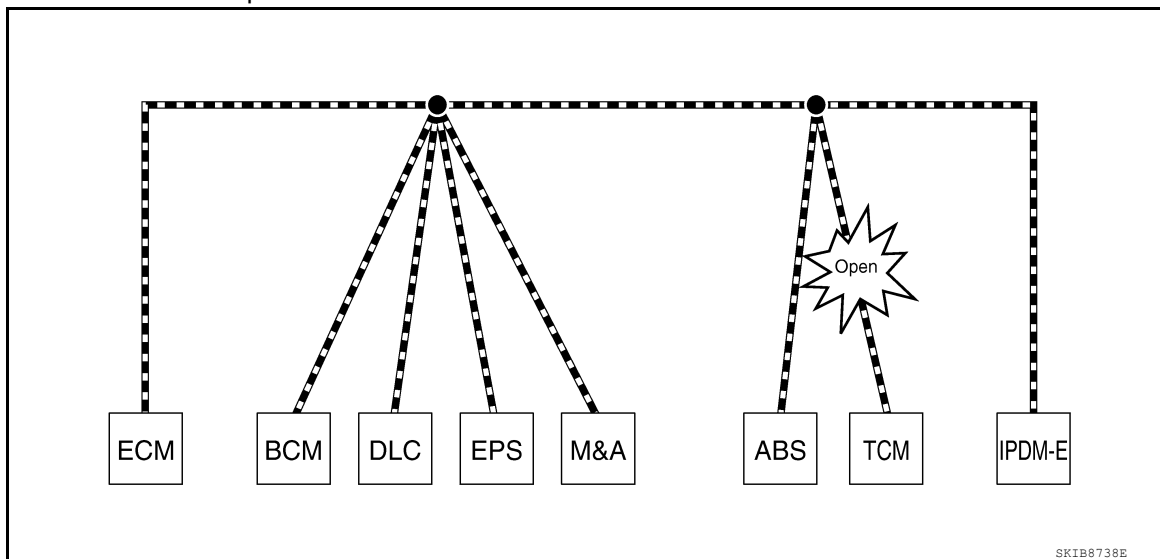

| Unit name | Symptom  |
|-----------|--|
| ECM       | Engine torque limiting is affected, and shift harshness increases. |
| BCM       | Reverse warning chime does not sound.                              |

A  
B  
C  
D  
E  
F  
G  
H  
I  
J  
K  
L  
N  
O  
P

LAN

# TROUBLE DIAGNOSIS

< SYSTEM DESCRIPTION >

[CAN FUNDAMENTAL]

| Unit name                                     | Symptom   |
|---|---|
| EPS control unit                              | Normal operation.   |
| Combination meter                             | <ul style="list-style-type: none"> <li>Shift position indicator and OD OFF indicator turn OFF.</li> <li>Warning lamps turn ON.</li> </ul> |
| ABS actuator and electric unit (control unit) | Normal operation.   |
| TCM   | No impact on operation.   |
| IPDM E/R                                      | Normal operation.   |

Example: Data link connector branch line open circuit

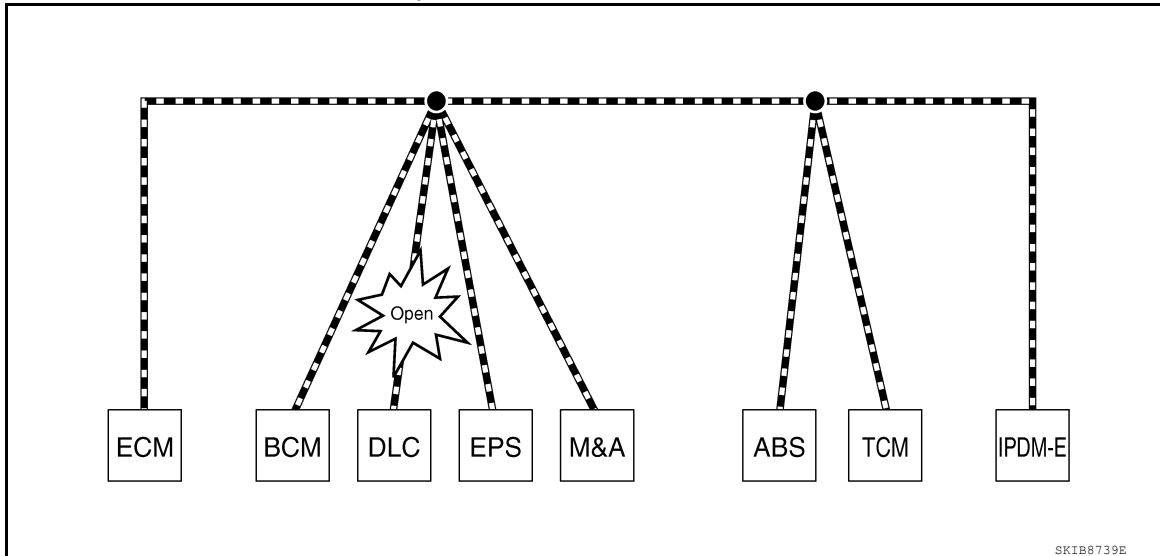

| Unit name                                     | Symptom           |
|---|-------------------|
| ECM   | Normal operation. |
| BCM   |                   |
| EPS control unit                              |                   |
| Combination meter                             |                   |
| ABS actuator and electric unit (control unit) |                   |
| TCM   |                   |
| IPDM E/R                                      |                   |

**NOTE:**

- When data link connector branch line is open, transmission and reception of CAN communication signals are not affected. Therefore, no symptoms occur. However, be sure to repair malfunctioning circuit.
- The model (all units on CAN communication system are Diag on CAN) cannot perform CAN diagnosis with CONSULT if the following error occurs. The error is judged by the symptom.

| Error  | Difference of symptom  |
|--|--|
| Data link connector branch line open circuit | Normal operation.  |
| CAN-H, CAN-L harness short-circuit           | Most of the units which are connected to the CAN communication system enter fail-safe mode or are deactivated. |

# TROUBLE DIAGNOSIS

< SYSTEM DESCRIPTION >

[CAN FUNDAMENTAL]

Example: Main Line Between Data Link Connector and ABS Actuator and Electric Unit (Control Unit) Open Circuit

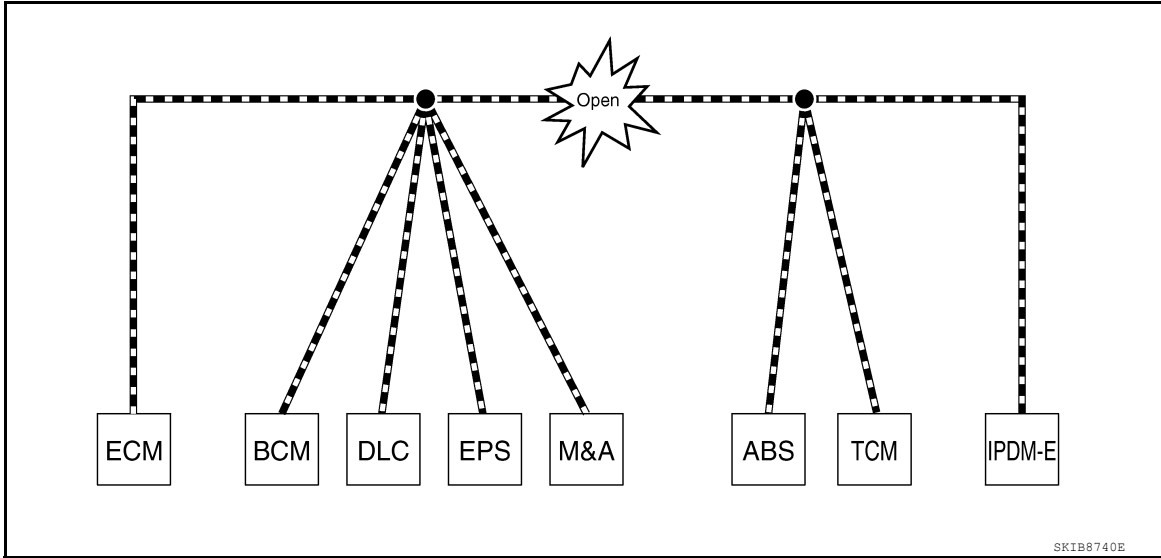

| Unit name                                     | Symptom   |
|---|---|
| ECM   | Engine torque limiting is affected, and shift harshness increases.  |
| BCM   | <ul style="list-style-type: none"> <li>• Reverse warning chime does not sound.</li> <li>• The front wiper moves under continuous operation mode even though the front wiper switch being in the intermittent position.</li> </ul> |
| EPS control unit                              | The steering effort increases.  |
| Combination meter                             | <ul style="list-style-type: none"> <li>• The shift position indicator and OD OFF indicator turn OFF.</li> <li>• The speedometer is inoperative.</li> <li>• The odo/trip meter stops.</li> </ul>                                   |
| ABS actuator and electric unit (control unit) | Normal operation.   |
| TCM   | No impact on operation.   |
| IPDM E/R                                      | When the ignition switch is ON, <ul style="list-style-type: none"> <li>• The headlamps (Lo) turn ON.</li> <li>• The cooling fan continues to rotate.</li> </ul>   |

Example: CAN-H, CAN-L Harness Short Circuit

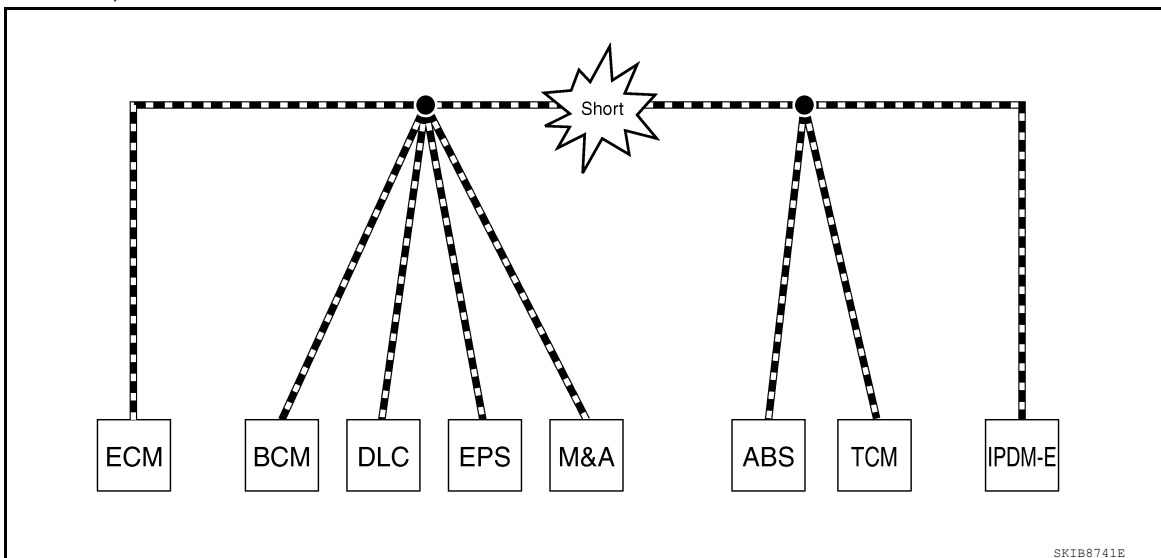

A  
B  
C  
D  
E  
F  
G  
H  
I  
J  
K  
L  
N  
O  
P

LAN

# TROUBLE DIAGNOSIS

< SYSTEM DESCRIPTION >

[CAN FUNDAMENTAL]

| Unit name                                     | Symptom   |
|---|---|
| ECM   | <ul style="list-style-type: none"> <li>• Engine torque limiting is affected, and shift harshness increases.</li> <li>• Engine speed drops.</li> </ul>   |
| BCM   | <ul style="list-style-type: none"> <li>• Reverse warning chime does not sound.</li> <li>• The front wiper moves under continuous operation mode even though the front wiper switch being in the intermittent position.</li> <li>• The room lamp does not turn ON.</li> <li>• The engine does not start (if an error or malfunction occurs while turning the ignition switch OFF.)</li> <li>• The steering lock does not release (if an error or malfunction occurs while turning the ignition switch OFF.)</li> </ul> |
| EPS control unit                              | The steering effort increases.  |
| Combination meter                             | <ul style="list-style-type: none"> <li>• The tachometer and the speedometer do not move.</li> <li>• Warning lamps turn ON.</li> <li>• Indicator lamps do not turn ON.</li> </ul>  |
| ABS actuator and electric unit (control unit) | Normal operation.   |
| TCM   | No impact on operation.   |
| IPDM E/R                                      | When the ignition switch is ON, <ul style="list-style-type: none"> <li>• The headlamps (Lo) turn ON.</li> <li>• The cooling fan continues to rotate.</li> </ul>   |

## CAN Diagnosis with CONSULT

INFOID:000000008634479

CAN diagnosis on CONSULT extracts the root cause by receiving the following information.

- Response to the system call
- Control unit diagnosis information
- Self-diagnosis
- CAN diagnostic support monitor

## Self-Diagnosis

INFOID:000000008634480

If communication signals cannot be transmitted or received among units communicating via CAN communication line, CAN communication-related DTC is displayed on the CONSULT "Self Diagnostic Result" screen.

**NOTE:**

The following table shows examples of CAN communication-related DTC. For other DTC, refer to the applicable sections.

| DTC   | Self-diagnosis item<br>(CONSULT indication) | DTC detection condition   |   | Inspection/Action  |
|-------|---|---|---|--|
| U1000 | CAN COMM CIRCUIT                            | ECM   | When ECM is not transmitting or receiving CAN communication signal of OBD (emission-related diagnosis) for 2 seconds or more. | Start the inspection. Refer to the applicable section of the indicated control unit. |
|       |   | Except for ECM  | When a control unit (except for ECM) is not transmitting or receiving CAN communication signal for 2 seconds or more.         |  |
| U1001 | CAN COMM CIRCUIT                            | When ECM is not transmitting or receiving CAN communication signal other than OBD (emission-related diagnosis) for 2 seconds or more. |   |  |
| U1002 | SYSTEM COMM                                 | When a control unit is not transmitting or receiving CAN communication signal for 2 seconds or less.                                  |   |  |
| U1010 | CONTROL UNIT(CAN)                           | When an error is detected during the initial diagnosis for CAN controller of each control unit.                                       |   |  |

## CAN Diagnostic Support Monitor

INFOID:000000008634481

MONITOR ITEM (CONSULT)

# TROUBLE DIAGNOSIS

< SYSTEM DESCRIPTION >

[CAN FUNDAMENTAL]

Example: CAN DIAG SUPPORT MNTR indication

| Without PAST  |         |      | With PAST     |               |      |
|---------------|---------|------|---------------|---------------|------|
| <b>BCM</b>    |         |      | <b>ENGINE</b> |               |      |
| MONITOR ITEM  | PRESENT | PAST | MONITOR ITEM  | PRESENT       | PAST |
| INITIAL DIAG  | OK      | -    | TRANSMIT DIAG | OK            | OK   |
| TRANSMIT DIAG | OK      | -    | VDC/TCS/ABS   | OK            | 5    |
| ECM           | OK      | -    | METER/M&A     | Not diagnosed | -    |
| METER/M&A     | OK      | -    | BCM/SEC       | OK            | OK   |
| TCM           | OK      | -    | ICC           | Not diagnosed | -    |
| IPDM E/R      | OK      | -    | HVAC          | Not diagnosed | -    |
| I-KEY         | OK      | -    | TCM           | OK            | OK   |
|               |         |      | EPS           | OK            | OK   |
|               |         |      | IPDM E/R      | OK            | 5    |
|               |         |      | e4WD          | Not diagnosed | -    |
|               |         |      | AWD/4WD       | Not diagnosed | -    |

JSMIA0964GB

Without PAST

| Item                                       | PRESENT | Description  |
|--|---------|--|
| Initial diagnosis                          | OK      | Normal at present  |
|  | NG      | Control unit error (Except for some control units)                           |
| Transmission diagnosis                     | OK      | Normal at present  |
|  | UNKWN   | Unable to transmit signals for 2 seconds or more.<br>Diagnosis not performed |
| Control unit name<br>(Reception diagnosis) | OK      | Normal at present  |
|  | UNKWN   | Unable to receive signals for 2 seconds or more.<br>Diagnosis not performed  |
|  | UNKWN   | No control unit for receiving signals. (No applicable optional parts)        |

With PAST

| Item                                       | PRESENT       | PAST   | Description  |
|--|---------------|--------|--|
| Transmission diagnosis                     | OK            | OK     | Normal at present and in the past  |
|  |               | 1 – 39 | Normal at present, but unable to transmit signals for 2 seconds or more in the past. (The number indicates the number of ignition switch cycles from OFF to ON.) |
|  | UNKWN         | 0      | Unable to transmit signals for 2 seconds or more at present.   |
| Control unit name<br>(Reception diagnosis) | OK            | OK     | Normal at present and in the past  |
|  |               | 1 – 39 | Normal at present, but unable to receive signals for 2 seconds or more in the past. (The number indicates the number of ignition switch cycles from OFF to ON.)  |
|  | UNKWN         | 0      | Unable to receive signals for 2 seconds or more at present.  |
|  | Not diagnosed | -      | Diagnosis not performed.<br>No control unit for receiving signals. (No applicable optional parts)  |

## MONITOR ITEM (ON-BOARD DIAGNOSIS)

### NOTE:

For some models, CAN communication diagnosis result is received from the vehicle monitor.

# TROUBLE DIAGNOSIS

[CAN FUNDAMENTAL]

< SYSTEM DESCRIPTION >

Example: Vehicle Display

| Item   | Result indicated | Error counter | Description   |
|--|------------------|---------------|---|
| CAN_COMM<br>(Initial diagnosis)                      | OK               | 0             | Normal at present   |
|  | NG               | 1 – 50        | Control unit error<br>(The number indicates how many times diagnosis has been run.)                                   |
| CAN_CIRC_1<br>(Transmission diagnosis)               | OK               | 0             | Normal at present   |
|  | UNKWN            | 1 – 50        | Unable to transmit for 2 seconds or more at present.<br>(The number indicates how many times diagnosis has been run.) |
| CAN_CIRC_2 – 9<br>(Reception diagnosis of each unit) | OK               | 0             | Normal at present   |
|  | UNKWN            | 1 – 50        | Unable to transmit for 2 seconds or more at present.<br>(The number indicates how many times diagnosis has been run.) |
|  |                  |               | Diagnosis not performed.  |
|  |                  |               | No control unit for receiving signals. (No applicable optional parts)   |

## How to Use CAN Communication Signal Chart

INFOID:000000008634482

The CAN communication signal chart lists the signals needed for trouble diagnosis. It is useful for detecting the root cause by finding a signal related to the symptom, and by checking transmission and reception unit.

Example: Tachometer does not move even though the engine rotates.

T: Transmit R: Receive

| Signal name/Connecting unit        | ECM | BCM | M&A | STRG | ABS | IPDM-E |
|------------------------------------|-----|-----|-----|------|-----|--------|
| A/C compressor feedback signal     | T   |     | R   |      |     |        |
| A/C compressor request signal      | T   |     |     |      |     | R      |
| Accelerator pedal position signal  | T   |     |     |      | R   |        |
| Cooling fan motor operation signal | T   |     |     |      |     | R      |
| Engine coolant temperature signal  | T   |     | R   |      |     |        |
| Engine speed signal                | T   |     | R   |      | R   |        |
| Fuel consumption monitor signal    | T   |     | R   |      |     |        |
| Malfunction indicator lamp signal  | T   |     | R   |      |     |        |
| A/C switch signal                  | R   | T   |     |      |     |        |
| Ignition switch signal             |     | T   |     |      |     | R      |
| Sleep/wake up signal               |     | T   | R   |      |     | R      |

↓

It indicates that an error occurs between ECM and M&A (Shaded area).

CAN-H, CAN-L

SKIB8715E

## BASIC INSPECTION

### DIAGNOSIS AND REPAIR WORKFLOW

#### Trouble Diagnosis Flow Chart

INFOID:000000008634483

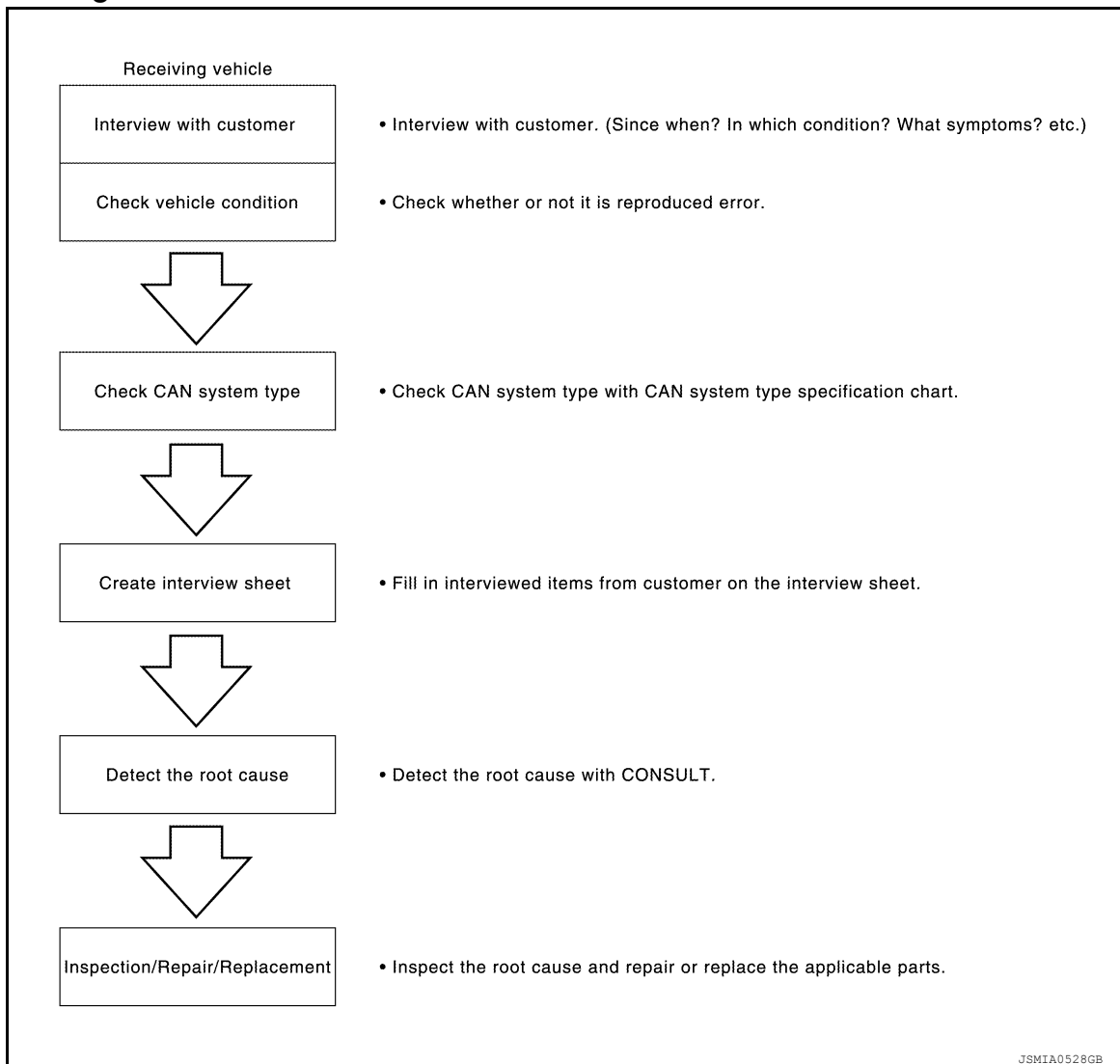

#### Trouble Diagnosis Procedure

INFOID:000000008634484

##### INTERVIEW WITH CUSTOMER

Interview with the customer is important to detect the root cause of CAN communication system errors and to understand vehicle condition and symptoms for proper trouble diagnosis.

##### Points in interview

- What: Parts name, system name
- When: Date, Frequency
- Where: Road condition, Place
- In what condition: Driving condition/environment
- Result: Symptom

##### NOTE:

- Check normal units as well as error symptoms.
- Example: Circuit between ECM and the combination meter is judged normal if the customer indicates tachometer functions normally.
- When a CAN communication system error is present, multiple control units may malfunction or go into fail-safe mode.

A  
B  
C  
D  
E  
F  
G  
H  
I  
J  
K  
L

LAN

N  
O  
P

# DIAGNOSIS AND REPAIR WORKFLOW

< BASIC INSPECTION >

[CAN FUNDAMENTAL]

- Indication of the combination meter is important to detect the root cause because it is the most obvious to the customer, and it performs CAN communication with many units.

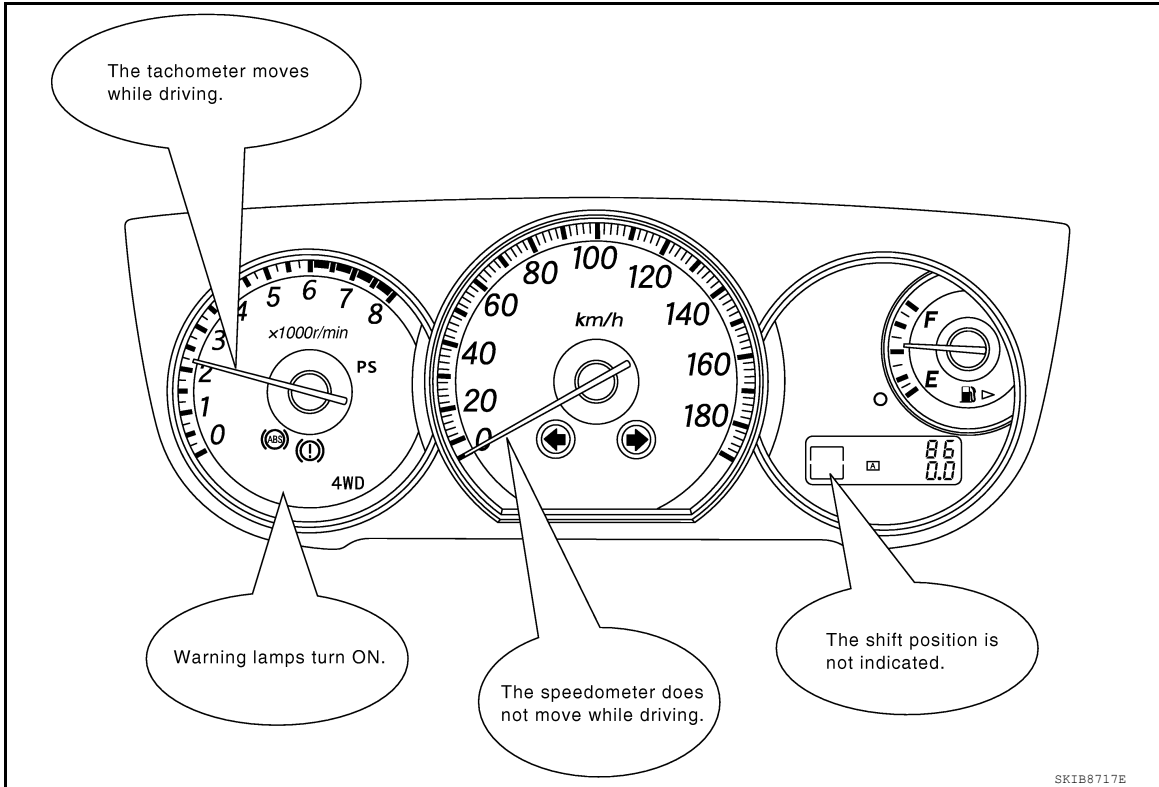

## INSPECTION OF VEHICLE CONDITION

Check whether the symptom is reproduced or not.

### NOTE:

Do not turn the ignition switch OFF or disconnect the battery cable while reproducing the error. The error may temporarily correct itself, making it difficult to determine the root cause.

## CHECK OF CAN SYSTEM TYPE (HOW TO USE CAN SYSTEM TYPE SPECIFICATION CHART)

Determine CAN system type based on vehicle equipment.

### NOTE:

- This chart is used if CONSULT does not automatically recognize CAN system type.
- There are two styles for CAN system type specification charts. Depending on the number of available system types, either style A or style B may be used.

CAN System Type Specification Chart (Style A)

### NOTE:



# DIAGNOSIS AND REPAIR WORKFLOW

< BASIC INSPECTION >

[CAN FUNDAMENTAL]

CAN system type is easily checked with the vehicle equipment identification information shown in the chart.

Example:  
Vehicle is equipped as follows: Wagon, AWD, VQ35DE, CVT, VDC, and Intelligent Key system. (○ shows an example of CAN system type.)

**CAN System Specification Chart**  
Determine CAN system type from the following specification chart.

|                                |                        |   |                        |     |                        |   |
|--------------------------------|------------------------|---|------------------------|-----|------------------------|---|
| Body type                      | Wagon                  |   |                        |     |                        |   |
| Axle                           | 2WD                    |   |                        | AWD |                        |   |
| Engine                         | QR25DE                 |   | VQ35DE                 |     |                        |   |
| Transmission                   | A/T                    |   |                        | CVT |                        |   |
| Brake control                  | ABS                    |   |                        |     | VDC                    |   |
| Intelligent Key system         |                        | X |                        | X   |                        | X |
| CAN system type                | 1                      | 2 | 3                      | 4   | 5                      | 6 |
| CAN communication signal chart | XX-XX. "TYPE 1/TYPE 2" |   | XX-XX. "TYPE 3/TYPE 4" |     | XX-XX. "TYPE 5/TYPE 6" |   |

X : Applicable

**VEHICLE EQUIPMENT IDENTIFICATION INFORMATION**  
**NOTE:**  
Check CAN system type from the vehicle shape and equipment.

With VDC

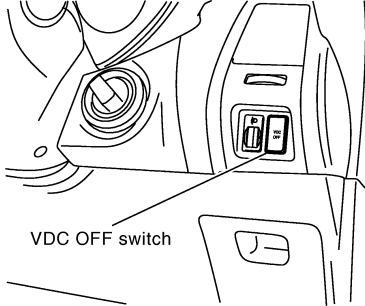

VDC OFF switch

With Intelligent Key system

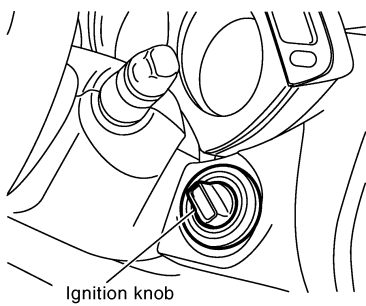

Ignition knob

[ For the above case, CAN system type is "6". ]

JSMIA0017GB

A  
B  
C  
D  
E  
F  
G  
H  
I  
J  
K  
L

CAN System Type Specification Chart (Style B)

**NOTE:**

LAN

N  
O  
P

# DIAGNOSIS AND REPAIR WORKFLOW

< BASIC INSPECTION >

[CAN FUNDAMENTAL]

CAN system type is easily checked with the vehicle equipment identification information shown in the chart.

Example:  
Vehicle is equipped as follows: Sedan, 2WD, MR20DE, CVT, ABS, Active AFS, Intelligent Key system, Navigation system and Automatic drive positioner. (○ shows an example of CAN system type.)

**CAN System Specification Chart**  
Refer to the specification as shown in the chart.

|                     |                           |                           |                           |
|---------------------|---------------------------|---------------------------|---------------------------|
| Body type           | Sedan                     |                           |                           |
| Axle                | 2WD                       |                           | AWD                       |
| Engine              | HR15DE                    | MR20DE                    | HR15DE                    |
| Transmission        | AT                        | CVT                       | AT                        |
| Brake control       | ABS                       |                           |                           |
| Specification chart | XXX SPECIFICATION CHART A | YYY SPECIFICATION CHART B | XXX SPECIFICATION CHART C |

x: Applicable

Check the vehicle equipment with the vehicle identification number plate.  
Check the vehicle equipment.  
Select the applicable vehicle equipment. Refer to the specification chart.

**SPECIFICATION CHART B**  
Determine CAN system type from the following specification chart.

|                                |   |    |    |    |    |    |    |    |    |    |    |    |
|--------------------------------|---|----|----|----|----|----|----|----|----|----|----|----|
| Body type                      | Sedan   |    |    |    |    |    |    |    |    |    |    |    |
| Axle                           | 2WD   |    |    |    |    |    |    |    |    |    |    |    |
| Engine                         | MR20DE  |    |    |    |    |    |    |    |    |    |    |    |
| Transmission                   | CVT   |    |    |    |    |    |    |    |    |    |    |    |
| Brake control                  | ABS   |    |    |    |    |    |    |    |    |    |    |    |
| Active AFS                     | x   |    |    | x  | x  |    | x  | x  |    | x  |    |    |
| Intelligent Key system         |   | x  |    | x  |    | x  | x  | x  | x  | x  |    |    |
| Navigation system              |   |    | x  |    |    | x  | x  |    | x  | x  |    |    |
| Automatic drive positioner     |   |    |    |    |    |    | x  |    | x  | x  |    |    |
| CAN system type                | 9   | 10 | 11 | 12 | 13 | 14 | 15 | 16 | 17 | 18 | 19 | 20 |
| CAN communication signal chart | XXX SPECIFICATION CHART A<br>YYY SPECIFICATION CHART B<br>ZZZ SPECIFICATION CHART C |    |    |    |    |    |    |    |    |    |    |    |

x: Applicable

Check the vehicle equipment.  
The number indicates the CAN system type of the vehicle.

**VEHICLE EQUIPMENT IDENTIFICATION INFORMATION**  
**NOTE:**  
Check CAN system type from the vehicle shape and equipment.

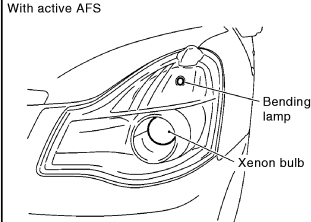
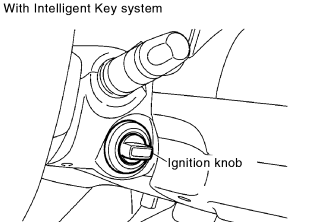
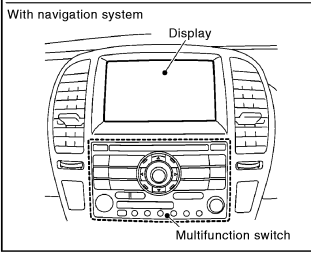
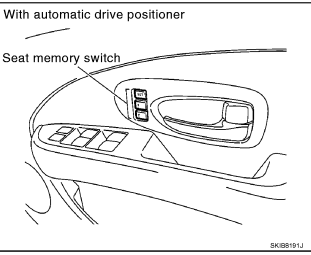
|   |  |
|---|--|
| With active AFS<br>        | With Intelligent Key system<br>     |
| With navigation system<br> | With automatic drive positioner<br> |

In the above example,  
• Checking Xenon bulb and bending lamp lead to judge whether or not Active AFS is equipped.  
• Checking the ignition knob leads to judge whether or not Intelligent Key system is equipped.  
• Checking display and multifunction switch lead to judge whether or not Navigation system is equipped.  
• Checking seat memory switch leads to judge whether or not Automatic drive positioner is equipped.

[ For the above case, CAN system type is "20". ]

JSMIA0018GB

## CREATE INTERVIEW SHEET

Fill out the symptom described by the customer, vehicle condition, and CAN system type on the interview sheet.

# DIAGNOSIS AND REPAIR WORKFLOW

< BASIC INSPECTION >

[CAN FUNDAMENTAL]

Interview Sheet (Example)

| CAN Communication System Diagnosis Interview Sheet   |                      |
|--|----------------------|
| Date received:   | 3, Feb. 2006         |
| Type: DBA-KG11   | VIN No.: KG11-005040 |
| Model: BDRARGZ397EDA-E-J-  |                      |
| First registration: 10, Jan. 2001  | Mileage: 62,140      |
| CAN system type:   | Type 19              |
| Symptom (Results from interview with customer)   |                      |
| <ul style="list-style-type: none"><li>• Headlamps suddenly turn ON while driving the vehicle.</li><li>• The engine does not restart after stopping the vehicle and turning the ignition switch OFF.</li><li>• The cooling fan continues rotating while turning the ignition switch ON.</li></ul> |                      |
| Condition at inspection  |                      |
| Error Symptom: Present / Past  |                      |
| <p>The engine does not start.<br/>While turning the ignition switch ON,</p> <ul style="list-style-type: none"><li>• The headlamps (Lo) turn ON, and the cooling fan continues rotating.</li><li>• The interior lamp does not turn ON.</li></ul>  |                      |

JSMIA0019GB

A  
B  
C  
D  
E  
F  
G  
H  
I  
J  
K  
L

LAN

DETECT THE ROOT CAUSE

CAN diagnosis function of CONSULT detects the root cause.

N  
O  
P

## HOW TO USE THIS SECTION

< HOW TO USE THIS MANUAL >

[CAN]

# HOW TO USE THIS MANUAL

## HOW TO USE THIS SECTION

### Caution

INFOID:000000008634485

- This section describes information peculiar to a vehicle and inspection procedures.
- For trouble diagnosis procedure, refer to [LAN-15, "Trouble Diagnosis Procedure"](#).

### Abbreviation List

INFOID:000000008634486

Unit name abbreviations in CONSULT CAN diagnosis and in this section are as per the following list.

| Abbreviation | Unit name                                     |
|--------------|---|
| A-BAG        | Air bag diagnosis sensor unit                 |
| ABS          | ABS actuator and electric unit (control unit) |
| ADP          | Driver seat control unit                      |
| AV           | AV control unit                               |
| BCM          | BCM   |
| DLC          | Data link connector                           |
| ECM          | ECM   |
| HVAC         | A/C auto amp.                                 |
| IPDM-E       | IPDM E/R                                      |
| M&A          | Combination meter                             |
| STRG         | Steering angle sensor                         |
| TCM          | TCM   |

PRECAUTION

PRECAUTIONS

Precaution for Supplemental Restraint System (SRS) "AIR BAG" and "SEAT BELT PRE-TENSIONER"

INFOID:000000008901879

The Supplemental Restraint System such as "AIR BAG" and "SEAT BELT PRE-TENSIONER", used along with a front seat belt, helps to reduce the risk or severity of injury to the driver and front passenger for certain types of collision. This system includes seat belt switch inputs and dual stage front air bag modules. The SRS system uses the seat belt switches to determine the front air bag deployment, and may only deploy one front air bag, depending on the severity of a collision and whether the front occupants are belted or unbelted. Information necessary to service the system safely is included in the SR and SB section of this Service Manual.

**WARNING:**

- To avoid rendering the SRS inoperative, which could increase the risk of personal injury or death in the event of a collision which would result in air bag inflation, all maintenance must be performed by an authorized NISSAN/INFINITI dealer.
- Improper maintenance, including incorrect removal and installation of the SRS, can lead to personal injury caused by unintentional activation of the system. For removal of Spiral Cable and Air Bag Module, see the SR section.
- Do not use electrical test equipment on any circuit related to the SRS unless instructed to in this Service Manual. SRS wiring harnesses can be identified by yellow and/or orange harnesses or harness connectors.

PRECAUTIONS WHEN USING POWER TOOLS (AIR OR ELECTRIC) AND HAMMERS

**WARNING:**

- When working near the Airbag Diagnosis Sensor Unit or other Airbag System sensors with the Ignition ON or engine running, DO NOT use air or electric power tools or strike near the sensor(s) with a hammer. Heavy vibration could activate the sensor(s) and deploy the air bag(s), possibly causing serious injury.
- When using air or electric power tools or hammers, always switch the Ignition OFF, disconnect the battery and wait at least 3 minutes before performing any service.

Precautions for Trouble Diagnosis

INFOID:000000008634488

**CAUTION:**

- Never apply 7.0 V or more to the measurement terminal.
- Use a tester with open terminal voltage of 7.0 V or less.
- Turn the ignition switch OFF and disconnect the battery cable from the negative terminal when checking the harness.

Precautions for Harness Repair

INFOID:000000008634489

- Solder the repaired area and wrap tape around the soldered area.

**NOTE:**

A fray of twisted lines must be within 110 mm (4.33 in).

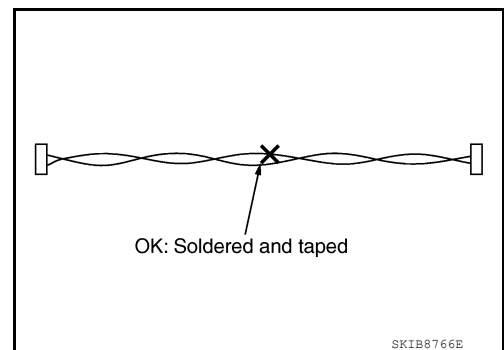

A  
B  
C  
D  
E  
F  
G  
H  
I  
J  
K  
L  
LAN  
N  
O  
P

## PRECAUTIONS

< PRECAUTION >

[CAN]

- Bypass connection is never allowed at the repaired area.

**NOTE:**

Bypass connection may cause CAN communication error. The spliced wire becomes separated and the characteristics of twisted line are lost.

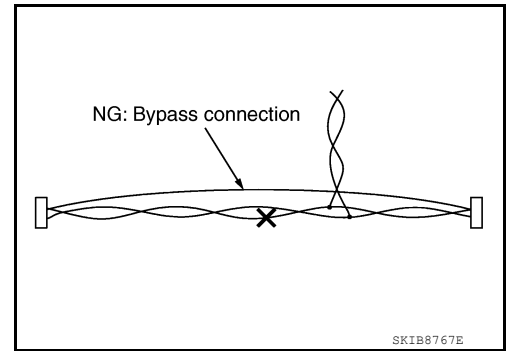

- Replace the applicable harness as an assembly if error is detected on the shield lines of CAN communication line.

# DIAGNOSIS AND REPAIR WORKFLOW

< BASIC INSPECTION >

[CAN]

## BASIC INSPECTION

### DIAGNOSIS AND REPAIR WORKFLOW

#### Interview Sheet

INFOID:000000008634490

|   |                               |
|---|-------------------------------|
| <b>CAN Communication System Diagnosis Interview Sheet</b> |                               |
| Date received: <input type="text"/>                       |                               |
| Type: <input type="text"/>                                | VIN No.: <input type="text"/> |
| Model: <input type="text"/>                               |                               |
| First registration: <input type="text"/>                  | Mileage: <input type="text"/> |
| CAN system type: <input type="text"/>                     |                               |
| Symptom (Results from interview with customer)            |                               |
| <input type="text"/>                                      |                               |
| Condition at inspection                                   |                               |
| Error symptom : Present / Past<br><input type="text"/>    |                               |

SKIB8898E

A  
B  
C  
D  
E  
F  
G  
H  
I  
J  
K  
L  
LAN  
N  
O  
P

# CAN COMMUNICATION SYSTEM

[CAN]

< SYSTEM DESCRIPTION >

## SYSTEM DESCRIPTION

### CAN COMMUNICATION SYSTEM

#### CAN System Specification Chart

INFOID:000000008634491

Determine CAN system type from the following specification chart.

**NOTE:**

Refer to [LAN-15. "Trouble Diagnosis Procedure"](#) for how to use CAN system specification chart.

|                            |                   |   |   |            |
|----------------------------|-------------------|---|---|------------|
| Body type                  | Sedan             |   |   |            |
| Axle                       | 2WD               |   |   |            |
| Engine                     | VQ35DE            |   |   |            |
| Transmission               | CVT               |   |   |            |
| Brake control              | VDC               |   |   |            |
| Destination                | Except for Mexico |   |   | For Mexico |
| Automatic drive positioner |                   |   | × | ×          |
| Color display              |                   | × | × | ×          |
| CAN system type            | 1                 | 3 | 4 | 5          |

×: Applicable

#### VEHICLE EQUIPMENT IDENTIFICATION INFORMATION

**NOTE:**

Check CAN system type from the vehicle shape and equipment.

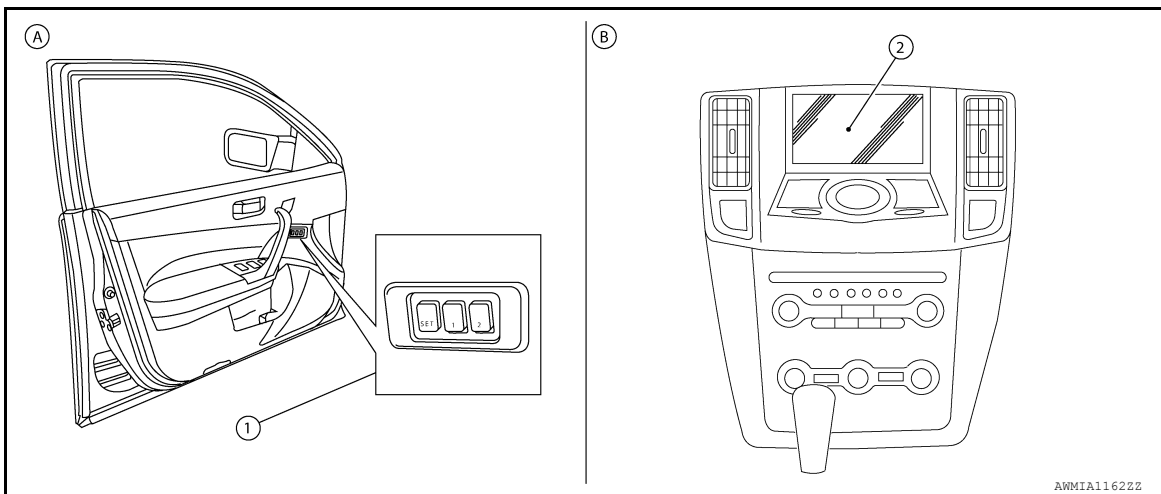

- 1. Seat memory switches
- 2. Color display
- A. With automatic drive positioner
- B. With color display

#### CAN Communication Signal Chart

INFOID:000000008634492

Refer to [LAN-14. "How to Use CAN Communication Signal Chart"](#) for how to use CAN communication signal chart.

**NOTE:**

Refer to [LAN-20. "Abbreviation List"](#) for the abbreviations of the connecting units.

T: Transmit R: Receive

| Signal name/Connecting unit       | ECM | ADP | BCM | M&A | AV | HVAC | STRG | ABS | TCM | IPDM-E |
|-----------------------------------|-----|-----|-----|-----|----|------|------|-----|-----|--------|
| A/C compressor request signal     | T   |     |     |     |    |      |      |     |     | R      |
| Accelerator pedal position signal | T   |     |     |     |    |      |      | R   | R   |        |



# CAN COMMUNICATION SYSTEM

< SYSTEM DESCRIPTION >

[CAN]

| Signal name/Connecting unit              | ECM | ADP | BCM | M&A | AV              | HVAC | STRG | ABS | TCM | IPDM-E | A   |
|--|-----|-----|-----|-----|-----------------|------|------|-----|-----|--------|-----|
| ASCD CRUISE indicator signal             | T   |     |     | R   |                 |      |      |     |     |        | A   |
| ASCD SET indicator signal                | T   |     |     | R   |                 |      |      |     |     |        | B   |
| Closed throttle position signal          | T   |     |     |     |                 |      |      |     | R   |        |     |
| Cooling fan speed request signal         | T   |     |     |     |                 |      |      |     |     | R      | C   |
| Engine and CVT integrated control signal | T   |     |     |     |                 |      |      |     | R   |        |     |
|  | R   |     |     |     |                 |      |      |     | T   |        |     |
| Engine coolant temperature signal        | T   |     | R   | R   | R               | R    |      | R   | R   |        | D   |
| Engine speed signal                      | T   |     |     | R   | R               | R    |      | R   | R   |        |     |
| Engine status signal                     | T   |     | R   |     |                 |      |      |     |     |        | E   |
| Fuel consumption monitor signal          | T   |     |     | R   |                 |      |      |     |     |        |     |
|  |     |     |     | T   | R               |      |      |     |     |        |     |
| Fuel filler cap warning display signal   | T   |     |     | R   |                 |      |      |     |     |        | F   |
| Malfunction indicator lamp signal        | T   |     |     | R   |                 |      |      |     |     |        |     |
| Power generation command value signal    | T   |     |     |     |                 |      |      |     |     | R      | G   |
| System setting signal                    |     | T   | T   |     | R               |      |      |     |     |        |     |
|  |     | R   | R   |     | T               |      |      |     |     |        |     |
| A/C switch signal                        | R   |     | T   |     |                 | T    |      |     |     |        | H   |
| Blower fan motor switch signal           | R   |     | T   |     |                 | T    |      |     |     |        |     |
| Steering angle sensor signal             |     |     |     |     | R <sup>*1</sup> |      | T    | R   |     |        | I   |
| Buzzer output signal                     |     |     | T   | R   |                 |      |      |     |     |        |     |
| Cornering lamp request signal            |     |     | T   |     |                 |      |      |     |     | R      |     |
| Day time running light request signal    |     |     | T   |     |                 | R    |      |     |     | R      | J   |
| Door lock/unlock status signal           |     | R   | T   |     |                 |      |      |     |     |        |     |
| Door switch signal                       |     | R   | T   | R   | R               |      |      |     |     | R      |     |
| Front fog light request signal           |     |     | T   | R   |                 | R    |      |     |     | R      | K   |
| Front wiper request signal               |     |     | T   |     |                 | R    |      | R   |     | R      |     |
| High beam request signal                 |     |     | T   | R   |                 | R    |      | R   |     | R      | L   |
| Horn chirp signal                        |     |     | T   |     |                 |      |      |     |     | R      |     |
| Ignition switch signal                   |     | R   | T   |     |                 |      |      |     |     | R      |     |
|  |     |     | R   |     |                 |      |      |     |     | T      | LAN |
| Key fob door unlock signal               |     | R   | T   |     |                 |      |      |     |     |        |     |
| Key fob ID signal                        |     | R   | T   |     |                 |      |      |     |     |        | N   |
| Key switch signal                        |     | R   | T   |     |                 |      |      |     |     |        |     |
| Key warning signal                       |     |     | T   | R   |                 |      |      |     |     |        |     |
| Low beam request signal                  |     |     | T   |     |                 | R    |      |     |     | R      | O   |
| Oil pressure switch signal               |     |     | T   | R   |                 |      |      |     |     |        |     |
|  |     |     | R   | R   |                 |      |      |     |     | T      | P   |
| Position light request signal            |     |     | T   | R   |                 | R    |      | R   |     | R      |     |
| Rear window defogger control signal      |     |     | T   |     |                 | R    |      |     |     | R      |     |
|  | R   |     |     |     | R               | R    |      |     |     | T      |     |
| Rear window defogger switch signal       |     |     | T   |     |                 | R    |      |     |     | R      |     |
| Sleep wake up signal                     |     | R   | T   | R   |                 |      |      |     |     | R      |     |
| Stop lamp switch signal                  |     |     | T   |     |                 |      |      |     | R   |        |     |

# CAN COMMUNICATION SYSTEM

< SYSTEM DESCRIPTION >

[CAN]

| Signal name/Connecting unit                    | ECM | ADP | BCM | M&A | AV | HVAC | STRG | ABS | TCM | IPDM-E |
|--|-----|-----|-----|-----|----|------|------|-----|-----|--------|
| Theft warning horn request signal              |     |     | T   |     |    |      |      |     |     | R      |
| Trunk switch signal                            |     |     | T   | R   | R  |      |      |     |     |        |
| Turn indicator signal                          |     |     | T   | R   |    | R    |      | R   |     |        |
| Distance to empty signal                       |     |     |     | T   | R  |      |      |     |     |        |
| Fuel filler cap warning reset signal           | R   |     |     | T   |    |      |      |     |     |        |
| Fuel level low warning signal                  |     |     |     | T   | R  |      |      |     |     |        |
| Fuel level sensor signal                       | R   |     |     | T   |    |      |      |     |     |        |
| Manual mode shift down signal                  |     |     |     | T   |    |      |      |     | R   |        |
| Manual mode shift up signal                    |     |     |     | T   |    |      |      |     | R   |        |
| Manual mode signal                             |     |     |     | T   |    |      |      |     | R   |        |
| Market information signal                      |     |     |     | T   | R  |      |      |     |     |        |
| Non-manual mode signal                         |     |     |     | T   |    |      |      |     | R   |        |
| Paddle shifter shift down signal* <sup>2</sup> |     |     |     | T   |    |      |      |     | R   |        |
| Paddle shifter shift up signal* <sup>2</sup>   |     |     |     | T   |    |      |      |     | R   |        |
| Parking brake switch signal                    |     |     | R   | T   | R  |      |      | R   |     |        |
| Seat belt buckle switch signal                 |     |     | R   | T   |    |      |      |     |     |        |
| Sleep-ready signal                             |     |     | R   | T   |    |      |      |     |     |        |
|  |     |     | R   |     |    |      |      |     |     | T      |
| Vehicle speed signal                           | R   | R   | R   | T   | R  |      |      |     |     | R      |
|  |     |     | R   | R   |    |      |      | T   | R   |        |
| A/C control signal                             |     |     |     |     | T  | R    |      |     |     |        |
|  |     |     |     |     | R  | T    |      |     |     |        |
| ABS operation signal                           |     |     |     |     |    |      |      | T   | R   |        |
| ABS warning lamp signal                        |     |     |     | R   |    |      |      | T   |     |        |
| Brake warning lamp signal                      |     |     |     | R   |    |      |      | T   |     |        |
| SLIP indicator lamp signal                     |     |     |     | R   |    |      |      | T   |     |        |
| TCS operation signal                           |     |     |     |     |    |      |      | T   | R   |        |
| VDC OFF indicator lamp signal                  |     |     |     | R   |    |      |      | T   |     |        |
| VDC operation signal                           |     |     |     |     |    |      |      | T   | R   |        |
| CVT indicator lamp signal                      |     |     |     | R   |    |      |      |     | T   |        |
| CVT self-diagnosis signal                      | R   |     |     |     |    |      |      |     | T   |        |
| Input shaft revolution signal                  | R   |     |     |     |    |      |      | R   | T   |        |
| Manual mode indicator signal                   |     |     |     | R   |    |      |      | R   | T   |        |
| Output shaft revolution signal                 | R   |     |     |     |    |      |      | R   | T   |        |
| P range signal                                 |     | R   | R   | R   | R  |      |      | R   | T   |        |
| R range signal                                 |     | R   | R   | R   | R  |      |      | R   | T   |        |
| Shift position signal                          |     |     |     | R   |    |      |      |     | T   |        |
| A/C compressor feedback signal                 |     |     |     |     |    | R    |      |     |     | T      |
| Cooling fan speed signal                       | R   |     |     |     |    |      |      |     |     | T      |
| Detention switch signal                        |     | R   | R   |     |    |      |      |     |     | T      |
| Front wiper stop position signal               |     |     | R   |     |    |      |      |     |     | T      |
| High beam status signal                        | R   |     |     |     | R  |      |      |     |     | T      |

# CAN COMMUNICATION SYSTEM

< SYSTEM DESCRIPTION >

[CAN]

| Signal name/Connecting unit               | ECM | ADP | BCM | M&A | AV | HVAC | STRG | ABS | TCM | IPDM-E |
|---|-----|-----|-----|-----|----|------|------|-----|-----|--------|
| Hood switch signal                        |     |     | R   |     | R  |      |      |     |     | T      |
| Low beam status signal                    | R   |     |     |     | R  |      |      |     |     | T      |
| Push-button ignition switch status signal |     |     | R   |     |    |      |      |     |     | T      |
| Steering lock unit status signal          |     |     | R   |     |    |      |      |     |     | T      |

\*1: Models with rear view monitor

\*2: Models with paddle shifter

**NOTE:**

CAN data of the air bag diagnosis sensor unit is not used by usual service work, thus it is omitted.

A  
B  
C  
D  
E  
F  
G  
H  
I  
J  
K  
L

LAN

N  
O  
P

# CAN SYSTEM

[CAN]

< WIRING DIAGRAM >

## WIRING DIAGRAM

### CAN SYSTEM

#### Wiring Diagram

INFOID:000000008634493

CAN SYSTEM

AD : WITH AUTOMATIC DRIVE POSITIONER  
XA : WITHOUT AUTOMATIC DRIVE POSITIONER

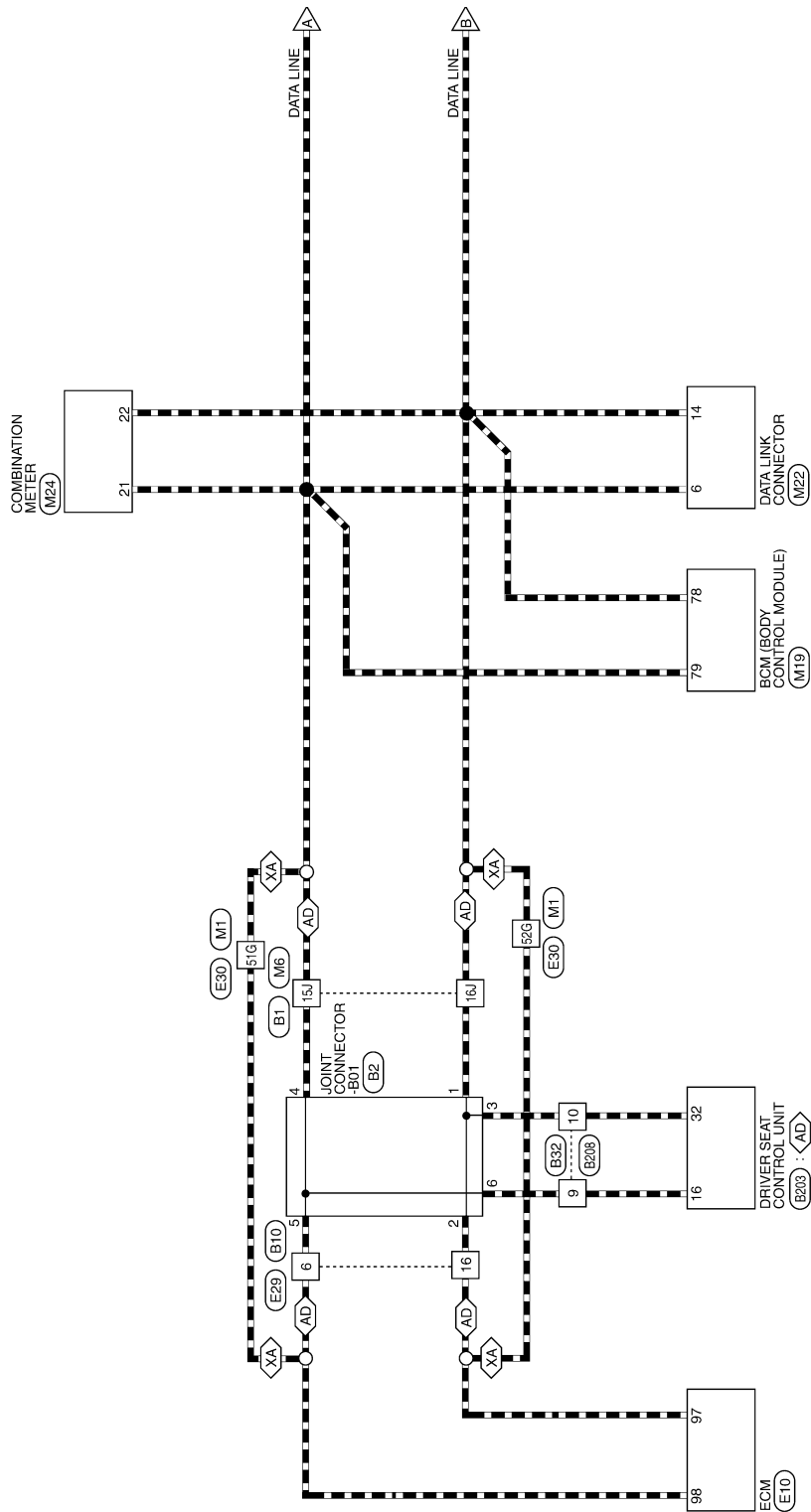

# CAN SYSTEM

< WIRING DIAGRAM >

[CAN]

- ◊CD◊ : WITH COLOR DISPLAY
- ◊EN◊ : WITHOUT NAVI
- ◊NV◊ : WITH NAVI
- ◊NX◊ : EXCEPT MEXICO
- ◊EN◊ : 87
- ◊NV◊ : 46
- \*1
- ◊EN◊ : 86
- ◊NV◊ : 62
- \*2

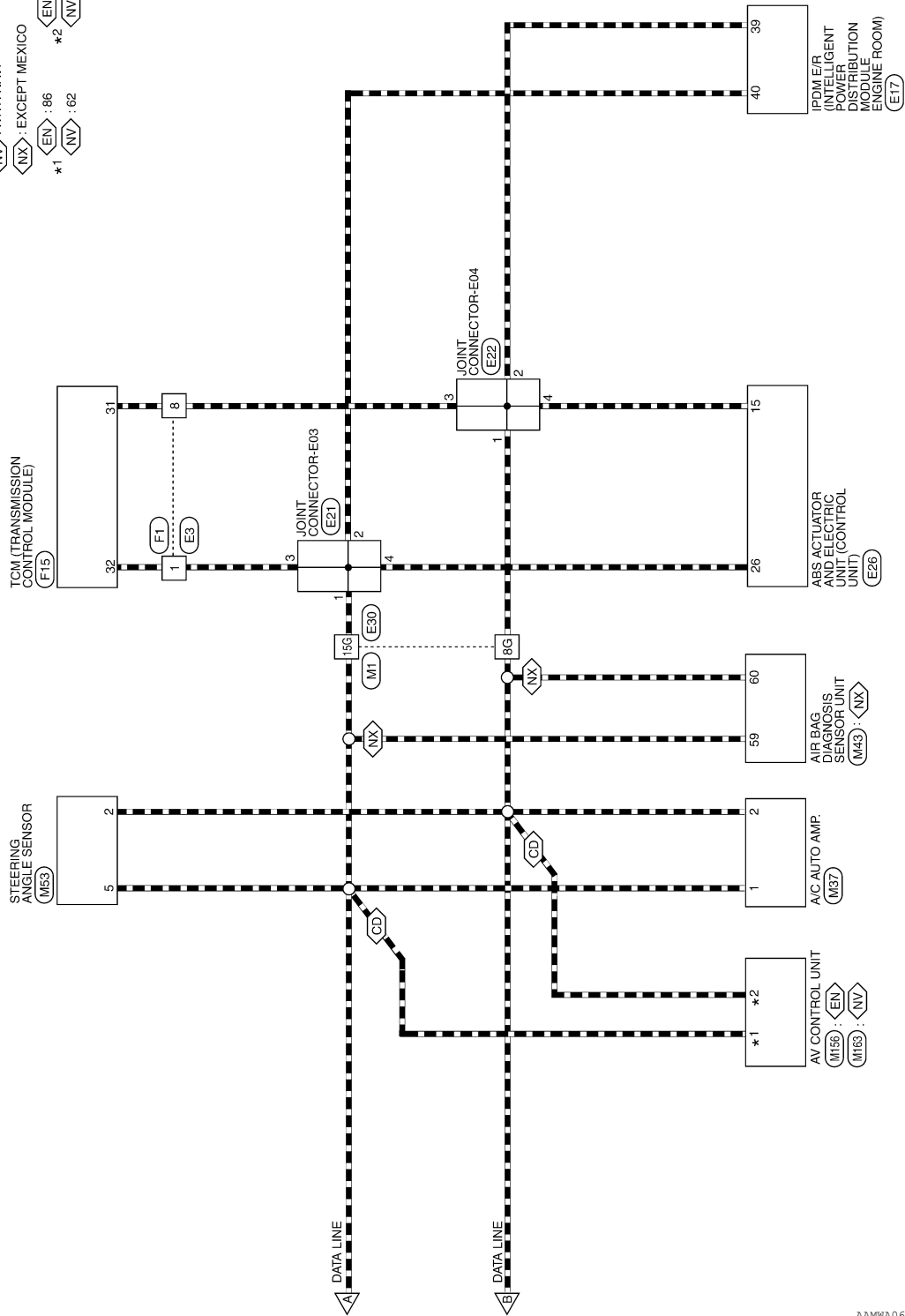

AAMWA0615GB

A  
B  
C  
D  
E  
F  
G  
H  
I  
J  
K  
L  
LAN  
N  
O  
P

CAN SYSTEM CONNECTORS

|                 |              |
|-----------------|--------------|
| Connector No.   | M1           |
| Connector Name  | WIRE TO WIRE |
| Connector Color | WHITE        |

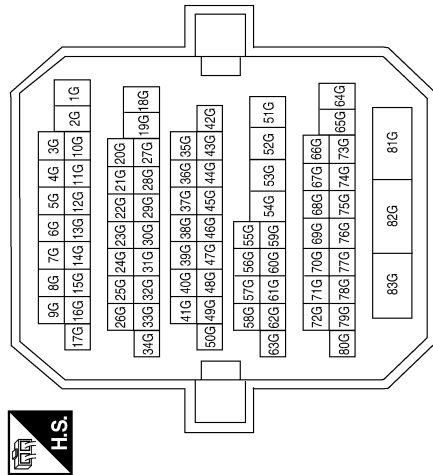

| Terminal No. | Color of Wire | Signal Name |
|--------------|---------------|-------------|
| 8G           | P             | -           |
| 15G          | L             | -           |
| 51G          | L             | -           |
| 52G          | P             | -           |

|                 |              |
|-----------------|--------------|
| Connector No.   | M6           |
| Connector Name  | WIRE TO WIRE |
| Connector Color | WHITE        |

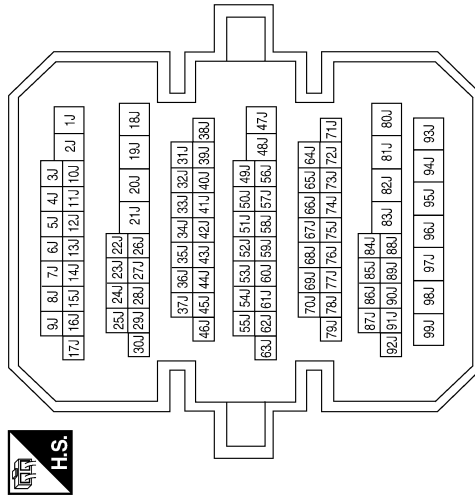

| Terminal No. | Color of Wire | Signal Name |
|--------------|---------------|-------------|
| 15J          | L             | -           |
| 16J          | P             | -           |

|                 |                           |
|-----------------|---------------------------|
| Connector No.   | M19                       |
| Connector Name  | BCM (BODY CONTROL MODULE) |
| Connector Color | BLACK                     |

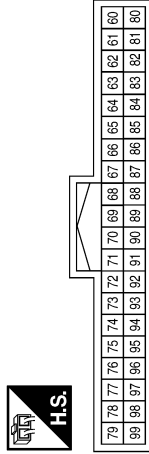

| Terminal No. | Color of Wire | Signal Name |
|--------------|---------------|-------------|
| 78           | P             | CAN-L       |
| 79           | L             | CAN-H       |

# CAN SYSTEM

< WIRING DIAGRAM >

[CAN]

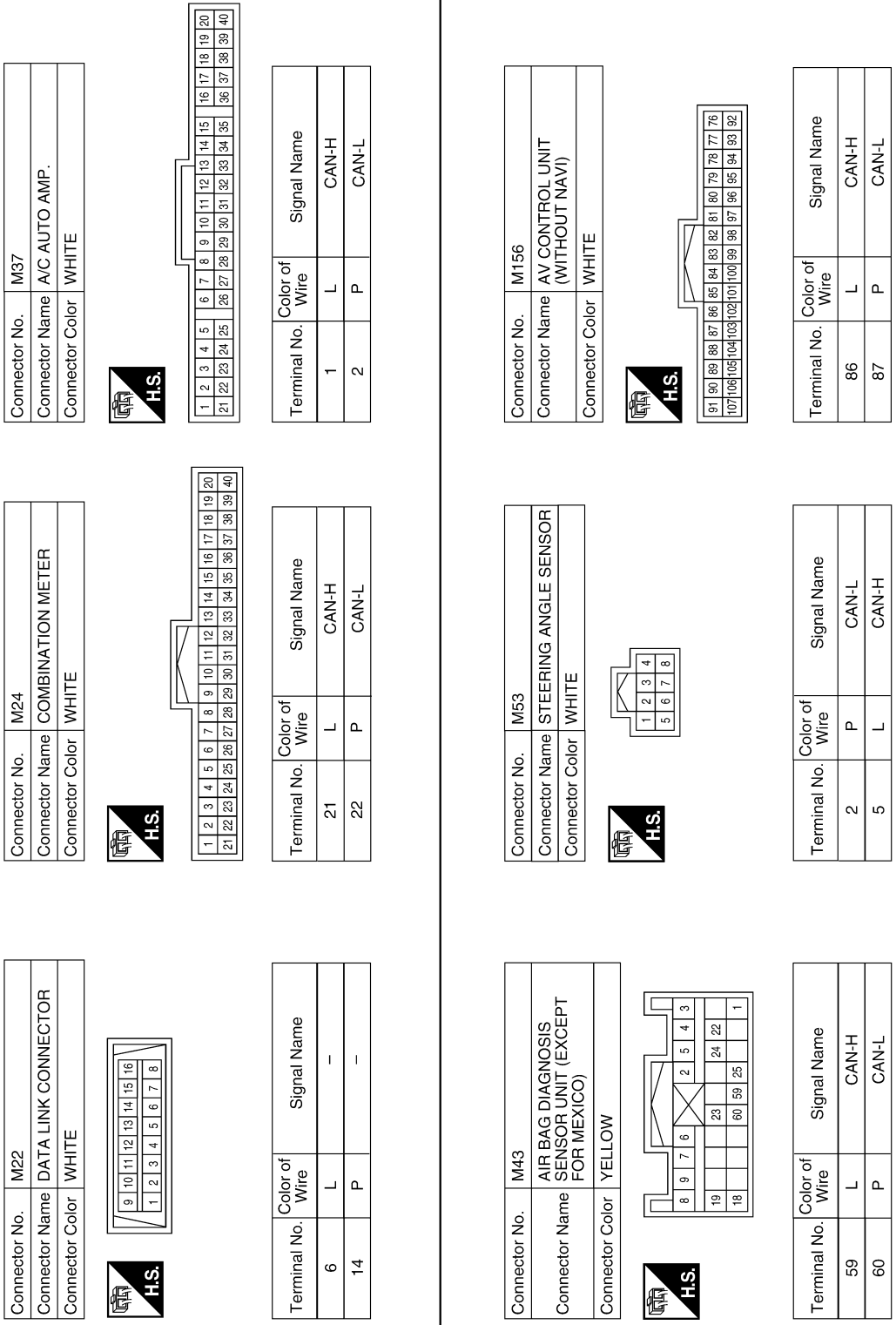

ABMIA4047GB

A  
B  
C  
D  
E  
F  
G  
H  
I  
J  
K  
L  
N  
O  
P

LAN

# CAN SYSTEM

< WIRING DIAGRAM >

[CAN]

|                 |       |
|-----------------|-------|
| Connector No.   | E10   |
| Connector Name  | ECM   |
| Connector Color | BLACK |

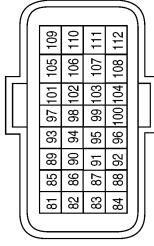

| Terminal No. | Color of Wire | Signal Name |
|--------------|---------------|-------------|
| 97           | P             | CAN-L       |
| 98           | L             | CAN-H       |

|                 |              |
|-----------------|--------------|
| Connector No.   | E3           |
| Connector Name  | WIRE TO WIRE |
| Connector Color | WHITE        |

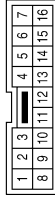

| Terminal No. | Color of Wire | Signal Name |
|--------------|---------------|-------------|
| 1            | L             | -           |
| 8            | P             | -           |

|                 |                            |
|-----------------|----------------------------|
| Connector No.   | M163                       |
| Connector Name  | AV CONTROL UNIT (WITH NAV) |
| Connector Color | WHITE                      |

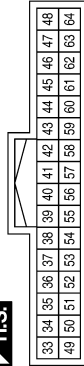

| Terminal No. | Color of Wire | Signal Name |
|--------------|---------------|-------------|
| 46           | P             | CAN-L       |
| 62           | L             | CAN-H       |

|                 |                     |
|-----------------|---------------------|
| Connector No.   | E22                 |
| Connector Name  | JOINT CONNECTOR-E04 |
| Connector Color | WHITE               |

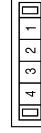

| Terminal No. | Color of Wire | Signal Name |
|--------------|---------------|-------------|
| 1            | P             | -           |
| 2            | P             | -           |
| 3            | P             | -           |
| 4            | P             | -           |

|                 |                     |
|-----------------|---------------------|
| Connector No.   | E21                 |
| Connector Name  | JOINT CONNECTOR-E03 |
| Connector Color | WHITE               |



| Terminal No. | Color of Wire | Signal Name |
|--------------|---------------|-------------|
| 1            | L             | -           |
| 2            | L             | -           |
| 3            | L             | -           |
| 4            | L             | -           |

|                 |  |
|-----------------|--|
| Connector No.   | E17  |
| Connector Name  | IPDM E/R (INTELLIGENT POWER DISTRIBUTION MODULE ENGINE ROOM) |
| Connector Color | WHITE  |

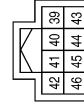

| Terminal No. | Color of Wire | Signal Name |
|--------------|---------------|-------------|
| 39           | P             | CAN-L       |
| 40           | L             | CAN-H       |

ABMIA2435GB



# CAN SYSTEM

< WIRING DIAGRAM >

[CAN]

|                 |              |
|-----------------|--------------|
| Connector No.   | E29          |
| Connector Name  | WIRE TO WIRE |
| Connector Color | WHITE        |

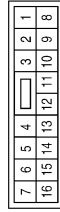

| Terminal No. | Color of Wire | Signal Name |
|--------------|---------------|-------------|
| 6            | L             | -           |
| 16           | P             | -           |

|                 |   |
|-----------------|---|
| Connector No.   | E26   |
| Connector Name  | ABS ACTUATOR AND ELECTRIC UNIT (CONTROL UNIT) |
| Connector Color | BLACK   |

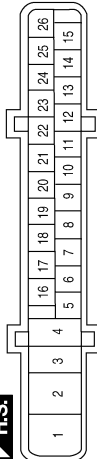

| Terminal No. | Color of Wire | Signal Name |
|--------------|---------------|-------------|
| 15           | P             | CAN-L       |
| 26           | L             | CAN-H       |

|                 |              |
|-----------------|--------------|
| Connector No.   | F1           |
| Connector Name  | WIRE TO WIRE |
| Connector Color | WHITE        |

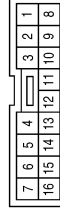

| Terminal No. | Color of Wire | Signal Name |
|--------------|---------------|-------------|
| 1            | L             | -           |
| 8            | P             | -           |

| Terminal No. | Color of Wire | Signal Name |
|--------------|---------------|-------------|
| 8G           | P             | -           |
| 15G          | L             | -           |
| 51G          | L             | -           |
| 52G          | P             | -           |

|                 |              |
|-----------------|--------------|
| Connector No.   | E30          |
| Connector Name  | WIRE TO WIRE |
| Connector Color | WHITE        |

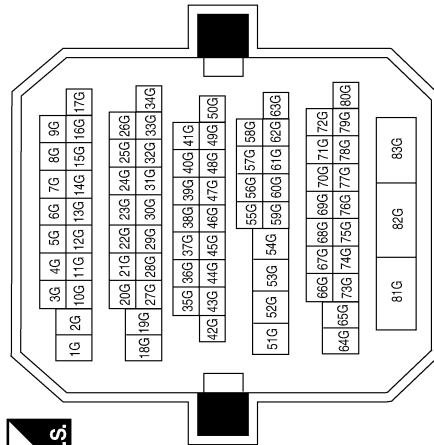

ABMIA2436GB

A  
B  
C  
D  
E  
F  
G  
H  
I  
J  
K  
L  
LAN  
N  
O  
P

# CAN SYSTEM

< WIRING DIAGRAM >

[CAN]

| Terminal No. | Color of Wire | Signal Name |
|--------------|---------------|-------------|
| 15J          | L             | -           |
| 16J          | P             | -           |

| Connector No.   | B1           |
|-----------------|--------------|
| Connector Name  | WIRE TO WIRE |
| Connector Color | WHITE        |

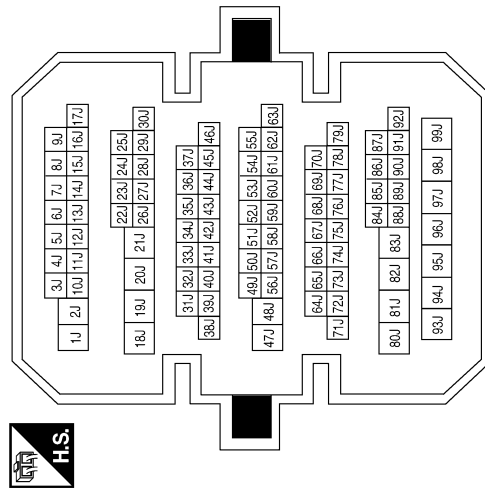

| Connector No.   | F15                               |
|-----------------|-----------------------------------|
| Connector Name  | TCM (TRANSMISSION CONTROL MODULE) |
| Connector Color | BLACK                             |

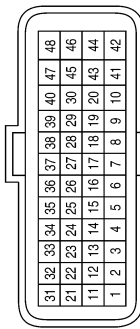

| Terminal No. | Color of Wire | Signal Name |
|--------------|---------------|-------------|
| 31           | P             | CAN-L       |
| 32           | L             | CAN-H       |

| Connector No.   | B32          |
|-----------------|--------------|
| Connector Name  | WIRE TO WIRE |
| Connector Color | WHITE        |



| Terminal No. | Color of Wire | Signal Name |
|--------------|---------------|-------------|
| 9            | L             | -           |
| 10           | P             | -           |

| Connector No.   | B10          |
|-----------------|--------------|
| Connector Name  | WIRE TO WIRE |
| Connector Color | WHITE        |

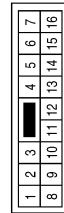

| Terminal No. | Color of Wire | Signal Name |
|--------------|---------------|-------------|
| 6            | L             | -           |
| 16           | P             | -           |

| Connector No.   | B2                  |
|-----------------|---------------------|
| Connector Name  | JOINT CONNECTOR-B01 |
| Connector Color | BLACK               |

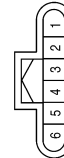

| Terminal No. | Color of Wire | Signal Name |
|--------------|---------------|-------------|
| 1            | P             | -           |
| 2            | P             | -           |
| 3            | P             | -           |
| 4            | L             | -           |
| 5            | L             | -           |
| 6            | L             | -           |

ABMIA2437GB

# CAN SYSTEM

< WIRING DIAGRAM >

[CAN]

A  
B  
C  
D  
E  
F  
G  
H  
I  
J  
K  
L  
LAN  
N  
O  
P

|                 |              |
|-----------------|--------------|
| Connector No.   | B208         |
| Connector Name  | WIRE TO WIRE |
| Connector Color | WHITE        |



| Terminal No. | Color of Wire | Signal Name |
|--------------|---------------|-------------|
| 9            | O/V           | -           |
| 10           | GR/B          | -           |

|                 |                          |
|-----------------|--------------------------|
| Connector No.   | B203                     |
| Connector Name  | DRIVER SEAT CONTROL UNIT |
| Connector Color | WHITE                    |

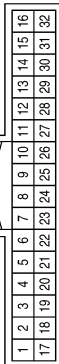

| Terminal No. | Color of Wire | Signal Name |
|--------------|---------------|-------------|
| 16           | O/V           | CAN-H       |
| 32           | GR/B          | CAN-L       |

ABMIA2438GB

## DTC/CIRCUIT DIAGNOSIS

### CAN COMMUNICATION SYSTEM

#### Component Parts Location

INFOID:000000008634494

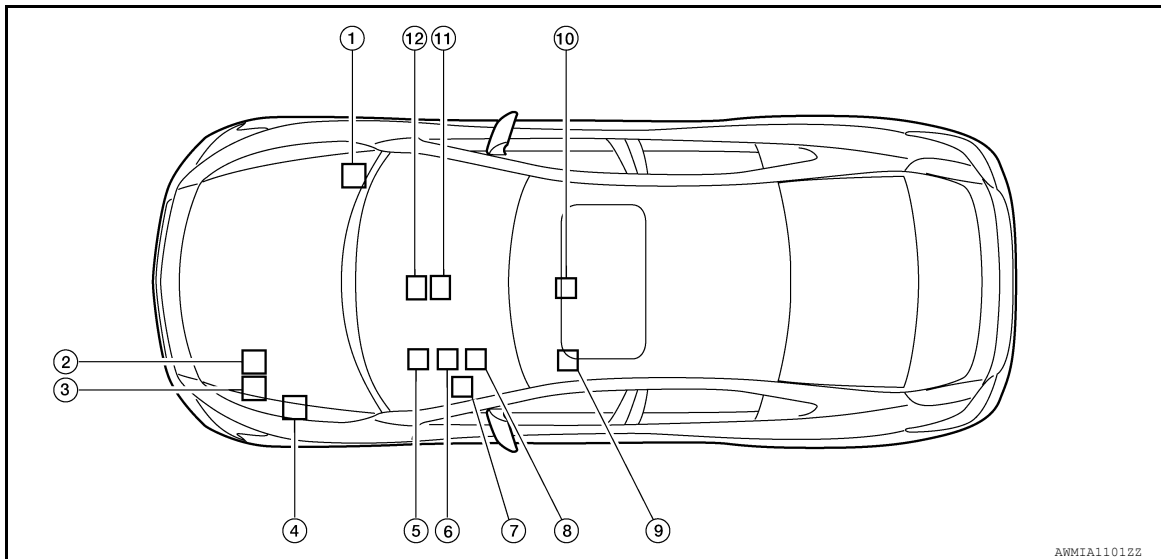

- |  |                              |  |
|--|------------------------------|--|
| 1. ABS actuator and electric unit (control unit) E26 | 2. TCM F15                   | 3. ECM E10   |
| 4. IPDM E/R E17                                      | 5. BCM M19                   | 6. Combination meter M24   |
| 7. Data link connector M22                           | 8. Steering angle sensor M53 | 9. Driver seat control unit B203   |
| 10. Air bag diagnosis sensor unit M43                | 11. A/C auto amp. M37        | 12. AV control unit<br>M156: Without navigation system<br>M163: With navigation system |

# MALFUNCTION AREA CHART

< DTC/CIRCUIT DIAGNOSIS >

[CAN]

## MALFUNCTION AREA CHART

### Main Line

INFOID:000000008634495

| Malfunction area  | Reference                                     |
|---|---|
| Main line between driver seat control unit and data link connector                                | <a href="#">LAN-38. "Diagnosis Procedure"</a> |
| Main line between data link connector and A/C auto amp.   | <a href="#">LAN-39. "Diagnosis Procedure"</a> |
| Main line between A/C auto amp. and ABS actuator and electric unit (control unit)                 | <a href="#">LAN-40. "Diagnosis Procedure"</a> |
| Main line between A/C auto amp. and air bag diagnosis sensor unit                                 | <a href="#">LAN-41. "Diagnosis Procedure"</a> |
| Main line between air bag diagnosis sensor unit and ABS actuator and electric unit (control unit) | <a href="#">LAN-42. "Diagnosis Procedure"</a> |

### Branch Line

INFOID:000000008634496

| Malfunction area  | Reference                                     |
|---|---|
| ECM branch line circuit   | <a href="#">LAN-43. "Diagnosis Procedure"</a> |
| Driver seat control unit branch line circuit                      | <a href="#">LAN-44. "Diagnosis Procedure"</a> |
| BCM branch line circuit   | <a href="#">LAN-45. "Diagnosis Procedure"</a> |
| Data link connector branch line circuit                           | <a href="#">LAN-46. "Diagnosis Procedure"</a> |
| Combination meter branch line circuit                             | <a href="#">LAN-47. "Diagnosis Procedure"</a> |
| AV control unit branch line circuit                               | <a href="#">LAN-48. "Diagnosis Procedure"</a> |
| A/C auto amp. branch line circuit                                 | <a href="#">LAN-49. "Diagnosis Procedure"</a> |
| Steering angle sensor branch line circuit                         | <a href="#">LAN-50. "Diagnosis Procedure"</a> |
| Air bag diagnosis sensor unit branch line circuit                 | <a href="#">LAN-51. "Diagnosis Procedure"</a> |
| ABS actuator and electric unit (control unit) branch line circuit | <a href="#">LAN-52. "Diagnosis Procedure"</a> |
| TCM branch line circuit   | <a href="#">LAN-53. "Diagnosis Procedure"</a> |
| IPDM E/R branch line circuit                                      | <a href="#">LAN-54. "Diagnosis Procedure"</a> |

### Short Circuit

INFOID:000000008634497

| Malfunction area          | Reference                                     |
|---------------------------|---|
| CAN communication circuit | <a href="#">LAN-55. "Diagnosis Procedure"</a> |

A  
B  
C  
D  
E  
F  
G  
H  
I  
J  
K  
L  
N  
O  
P

LAN

# MAIN LINE BETWEEN ADP AND DLC CIRCUIT

< DTC/CIRCUIT DIAGNOSIS >

[CAN]

## MAIN LINE BETWEEN ADP AND DLC CIRCUIT

### Diagnosis Procedure

INFOID:000000008634498

#### 1. CHECK CONNECTOR

1. Turn the ignition switch OFF.
2. Disconnect the battery cable from the negative terminal.
3. Check the following terminals and connectors for damage, bend and loose connection (connector side and harness side).
  - Harness connector B1
  - Harness connector M6

Is the inspection result normal?

YES >> GO TO 2.

NO >> Repair the terminal and connector.

#### 2. CHECK HARNESS CONTINUITY (OPEN CIRCUIT)

1. Disconnect the following harness connectors.
  - Harness connectors B208 and B32
  - Harness connectors B1 and M6
2. Check the continuity between the harness connectors.

| Harness connector |              | Harness connector |              | Continuity |
|-------------------|--------------|-------------------|--------------|------------|
| Connector No.     | Terminal No. | Connector No.     | Terminal No. |            |
| B32               | 9            | B1                | 15J          | Existed    |
|                   | 10           |                   | 16J          | Existed    |

Is the inspection result normal?

YES >> GO TO 3.

NO >> Repair the main line between the harness connectors B32 and B1.

#### 3. CHECK HARNESS CONTINUITY (OPEN CIRCUIT)

Check the continuity between the harness connector and the data link connector.

| Harness connector |              | Data link connector |              | Continuity |
|-------------------|--------------|---------------------|--------------|------------|
| Connector No.     | Terminal No. | Connector No.       | Terminal No. |            |
| M6                | 15J          | M22                 | 6            | Existed    |
|                   | 16J          |                     | 14           | Existed    |

Is the inspection result normal?

YES (Present error)>>Check CAN system type decision again.

YES (Past error)>>Error was detected in the main line between the driver seat control unit and the data link connector.

NO >> Repair the main line between the harness connector M6 and the data link connector.

# MAIN LINE BETWEEN DLC AND HVAC CIRCUIT

< DTC/CIRCUIT DIAGNOSIS >

[CAN]

## MAIN LINE BETWEEN DLC AND HVAC CIRCUIT

### Diagnosis Procedure

INFOID:000000008634499

#### 1. CHECK HARNESS CONTINUITY (OPEN CIRCUIT)

1. Turn the ignition switch OFF.
2. Disconnect the battery cable from the negative terminal.
3. Disconnect the following harness connectors.
  - ECM
  - A/C auto amp.
4. Check the continuity between the data link connector and the A/C auto amp. harness connector.

| Data link connector |              | A/C auto amp. harness connector |              | Continuity |
|---------------------|--------------|---------------------------------|--------------|------------|
| Connector No.       | Terminal No. | Connector No.                   | Terminal No. |            |
| M22                 | 6            | M37                             | 1            | Existed    |
|                     | 14           |                                 | 2            | Existed    |

#### Is the inspection result normal?

YES (Present error)>>Check CAN system type decision again.

YES (Past error)>>Error was detected in the main line between the data link connector and the A/C auto amp.

NO >> Repair the main line between the data link connector and the A/C auto amp.

LAN

# MAIN LINE BETWEEN HVAC AND ABS CIRCUIT

< DTC/CIRCUIT DIAGNOSIS >

[CAN]

## MAIN LINE BETWEEN HVAC AND ABS CIRCUIT

### Diagnosis Procedure

INFOID:000000008634500

#### 1.CHECK CONNECTOR

1. Turn the ignition switch OFF.
2. Disconnect the battery cable from the negative terminal.
3. Check the following terminals and connectors for damage, bend and loose connection (connector side and harness side).
  - Harness connector M1
  - Harness connector E30

Is the inspection result normal?

YES >> GO TO 2.

NO >> Repair the terminal and connector.

#### 2.CHECK HARNESS CONTINUITY (OPEN CIRCUIT)

1. Disconnect the following harness connectors.
  - A/C auto amp.
  - Harness connectors M1 and E30
2. Check the continuity between the A/C auto amp. harness connector and the harness connector.

| A/C auto amp. harness connector |              | Harness connector |              | Continuity |
|---------------------------------|--------------|-------------------|--------------|------------|
| Connector No.                   | Terminal No. | Connector No.     | Terminal No. |            |
| M37                             | 1            | M1                | 15G          | Existed    |
|                                 | 2            |                   | 8G           | Existed    |

Is the inspection result normal?

YES >> GO TO 3.

NO >> Repair the main line between the A/C auto amp. and the harness connector M1.

#### 3.CHECK HARNESS CONTINUITY (OPEN CIRCUIT)

1. Disconnect the connector of ABS actuator and electric unit (control unit).
2. Check the continuity between the harness connector and the ABS actuator and electric unit (control unit) harness connector.

| Harness connector |              | ABS actuator and electric unit (control unit) harness connector |              | Continuity |
|-------------------|--------------|---|--------------|------------|
| Connector No.     | Terminal No. | Connector No.   | Terminal No. |            |
| E30               | 15G          | E26   | 26           | Existed    |
|                   | 8G           |   | 15           | Existed    |

Is the inspection result normal?

YES (Present error)>>Check CAN system type decision again.

YES (Past error)>>Error was detected in the main line between the A/C auto amp. and the ABS actuator and electric unit (control unit).

NO >> Repair the main line between the harness connector E30 and the ABS actuator and electric unit (control unit).



# MAIN LINE BETWEEN HVAC AND A-BAG CIRCUIT

< DTC/CIRCUIT DIAGNOSIS >

[CAN]

## MAIN LINE BETWEEN HVAC AND A-BAG CIRCUIT

### Diagnosis Procedure

INFOID:000000008634501

#### 1. CHECK HARNESS CONTINUITY (OPEN CIRCUIT)

1. Turn the ignition switch OFF.
2. Disconnect the battery cable from the negative terminal.
3. Disconnect the following harness connectors.
  - A/C auto amp.
  - Harness connectors M1 and E30
4. Check the continuity between the harness connector and the A/C auto amp. harness connector.

| A/C auto amp. harness connector |              | Harness connector |              | Continuity |
|---------------------------------|--------------|-------------------|--------------|------------|
| Connector No.                   | Terminal No. | Connector No.     | Terminal No. |            |
| M37                             | 1            | M1                | 15G          | Existed    |
|                                 | 2            |                   | 8G           | Existed    |

#### Is the inspection result normal?

YES (Present error)>>Check CAN system type decision again.

YES (Past error)>>Error was detected in the main line between the A/C auto amp. and the air bag diagnosis sensor unit.

NO >> Repair the main line between the A/C auto amp. and the air bag diagnosis sensor unit.

LAN

# MAIN LINE BETWEEN A-BAG AND ABS CIRCUIT

< DTC/CIRCUIT DIAGNOSIS >

[CAN]

## MAIN LINE BETWEEN A-BAG AND ABS CIRCUIT

### Diagnosis Procedure

INFOID:000000008634502

#### 1.CHECK CONNECTOR

1. Turn the ignition switch OFF.
2. Disconnect the battery cable from the negative terminal.
3. Check the following terminals and connectors for damage, bend and loose connection (connector side and harness side).
  - Harness connector M1
  - Harness connector E30

Is the inspection result normal?

YES >> GO TO 2.

NO >> Repair the terminal and connector.

#### 2.CHECK HARNESS CONTINUITY (OPEN CIRCUIT)

1. Disconnect the following harness connectors.
  - A/C auto amp.
  - Harness connectors M1 and E30
2. Check the continuity between the A/C auto amp. harness connector and the harness connector.

| A/C auto amp. harness connector |              | Harness connector |              | Continuity |
|---------------------------------|--------------|-------------------|--------------|------------|
| Connector No.                   | Terminal No. | Connector No.     | Terminal No. |            |
| M37                             | 1            | M1                | 15G          | Existed    |
|                                 | 2            |                   | 8G           | Existed    |

Is the inspection result normal?

YES >> GO TO 3.

NO >> Repair the main line between the air bag diagnosis sensor unit and the harness connector M1.

#### 3.CHECK HARNESS CONTINUITY (OPEN CIRCUIT)

1. Disconnect the connector of ABS actuator and electric unit (control unit).
2. Check the continuity between the harness connector and the ABS actuator and electric unit (control unit) harness connector.

| Harness connector |              | ABS actuator and electric unit (control unit) harness connector |              | Continuity |
|-------------------|--------------|---|--------------|------------|
| Connector No.     | Terminal No. | Connector No.   | Terminal No. |            |
| E30               | 15G          | E26   | 26           | Existed    |
|                   | 8G           |   | 15           | Existed    |

Is the inspection result normal?

YES (Present error)>>Check CAN system type decision again.

YES (Past error)>>Error was detected in the main line between the air bag diagnosis sensor unit and the ABS actuator and electric unit (control unit).

NO >> Repair the main line between the harness connector E30 and the ABS actuator and electric unit (control unit).

# ECM BRANCH LINE CIRCUIT

< DTC/CIRCUIT DIAGNOSIS >

[CAN]

## ECM BRANCH LINE CIRCUIT

### Diagnosis Procedure

INFOID:000000008634503

#### 1. CHECK CONNECTOR

1. Turn the ignition switch OFF.
2. Disconnect the battery cable from the negative terminal.
3. Check the following terminals and connectors for damage, bend and loose connection (unit side and connector side).
  - Models without automatic drive positioner
    - ECM
    - Harness connector E30
    - Harness connector M1
  - Models with automatic drive positioner
    - ECM
    - Harness connector E29
    - Harness connector B10

Is the inspection result normal?

YES >> GO TO 2.

NO >> Repair the terminal and connector.

#### 2. CHECK HARNESS FOR OPEN CIRCUIT

1. Disconnect the connector of ECM.
2. Check the resistance between the ECM harness connector terminals.

| ECM harness connector |              | Resistance (Ω)    |
|-----------------------|--------------|-------------------|
| Connector No.         | Terminal No. |                   |
| E10                   | 98           | Approx. 108 – 132 |
|                       | 97           |                   |

Is the measurement value within the specification?

YES >> GO TO 3.

NO >> Repair the ECM branch line.

#### 3. CHECK POWER SUPPLY AND GROUND CIRCUIT

Check the power supply and the ground circuit of the ECM. Refer to [EC-155, "Diagnosis Procedure"](#).

Is the inspection result normal?

YES (Present error)>>Replace the ECM. Refer to [EC-17, "ADDITIONAL SERVICE WHEN REPLACING CONTROL UNIT : Description"](#).

YES (Past error)>>Error was detected in the ECM branch line.

NO >> Repair the power supply and the ground circuit.

LAN

# ADP BRANCH LINE CIRCUIT

< DTC/CIRCUIT DIAGNOSIS >

[CAN]

## ADP BRANCH LINE CIRCUIT

### Diagnosis Procedure

INFOID:000000008634504

#### 1. CHECK CONNECTOR

1. Turn the ignition switch OFF.
2. Disconnect the battery cable from the negative terminal.
3. Check the following terminals and connectors for damage, bend and loose connection (unit side and connector side).
  - Driver seat control unit
  - Harness connector B208
  - Harness connector B32

Is the inspection result normal?

YES >> GO TO 2.

NO >> Repair the terminal and connector.

#### 2. CHECK HARNESS FOR OPEN CIRCUIT

1. Disconnect the connector of driver seat control unit.
2. Check the resistance between the driver seat control unit harness connector terminals.

| Driver seat control unit harness connector |              |    | Resistance (Ω)  |
|--|--------------|----|-----------------|
| Connector No.                              | Terminal No. |    |                 |
| B203                                       | 16           | 32 | Approx. 54 – 66 |

Is the measurement value within the specification?

YES >> GO TO 3.

NO >> Repair the driver seat control unit branch line.

#### 3. CHECK POWER SUPPLY AND GROUND CIRCUIT

Check the power supply and the ground circuit of the driver seat control unit. Refer to [ADP-47, "DRIVER SEAT CONTROL UNIT : Diagnosis Procedure"](#).

Is the inspection result normal?

YES (Present error)>>Replace the driver seat control unit. Refer to [ADP-168, "Removal and Installation"](#).

YES (Past error)>>Error was detected in the driver seat control unit branch line.

NO >> Repair the power supply and the ground circuit.

# BCM BRANCH LINE CIRCUIT

< DTC/CIRCUIT DIAGNOSIS >

[CAN]

## BCM BRANCH LINE CIRCUIT

### Diagnosis Procedure

INFOID:000000008634505

#### 1. CHECK CONNECTOR

1. Turn the ignition switch OFF.
2. Disconnect the battery cable from the negative terminal.
3. Check the terminals and connectors of the BCM for damage, bend and loose connection (unit side and connector side).

Is the inspection result normal?

- YES >> GO TO 2.  
NO >> Repair the terminal and connector.

#### 2. CHECK HARNESS FOR OPEN CIRCUIT

1. Disconnect the connector of BCM.
2. Check the resistance between the BCM harness connector terminals.

| BCM harness connector |              |    | Resistance (Ω)  |
|-----------------------|--------------|----|-----------------|
| Connector No.         | Terminal No. |    |                 |
| M19                   | 79           | 78 | Approx. 54 – 66 |

Is the measurement value within the specification?

- YES >> GO TO 3.  
NO >> Repair the BCM branch line.

#### 3. CHECK POWER SUPPLY AND GROUND CIRCUIT

Check the power supply and the ground circuit of the BCM. Refer to [BCS-36, "Diagnosis Procedure"](#).

Is the inspection result normal?

- YES (Present error)>>Replace the BCM. Refer to [BCS-79, "Removal and Installation"](#).  
YES (Past error)>>Error was detected in the BCM branch line.  
NO >> Repair the power supply and the ground circuit.

A  
B  
C  
D  
E  
F  
G  
H  
I  
J  
K  
L

LAN

N  
O  
P

# DLC BRANCH LINE CIRCUIT

< DTC/CIRCUIT DIAGNOSIS >

[CAN]

## DLC BRANCH LINE CIRCUIT

### Diagnosis Procedure

INFOID:000000008634506

#### 1. CHECK CONNECTOR

1. Turn the ignition switch OFF.
2. Disconnect the battery cable from the negative terminal.
3. Check the terminals and connectors of the data link connector for damage, bend and loose connection (connector side and harness side).

Is the inspection result normal?

- YES >> GO TO 2.  
NO >> Repair the terminal and connector.

#### 2. CHECK HARNESS FOR OPEN CIRCUIT

Check the resistance between the data link connector terminals.

| Data link connector |              |    | Resistance ( $\Omega$ ) |
|---------------------|--------------|----|-------------------------|
| Connector No.       | Terminal No. |    |                         |
| M22                 | 6            | 14 | Approx. 54 – 66         |

Is the measurement value within the specification?

- YES (Present error)>>Check CAN system type decision again.  
YES (Past error)>>Error was detected in the data link connector branch line circuit.  
NO >> Repair the data link connector branch line.

# M&A BRANCH LINE CIRCUIT

< DTC/CIRCUIT DIAGNOSIS >

[CAN]

## M&A BRANCH LINE CIRCUIT

### Diagnosis Procedure

INFOID:000000008634507

#### 1. CHECK CONNECTOR

1. Turn the ignition switch OFF.
2. Disconnect the battery cable from the negative terminal.
3. Check the terminals and connectors of the combination meter for damage, bend and loose connection (unit side and connector side).

Is the inspection result normal?

- YES >> GO TO 2.  
NO >> Repair the terminal and connector.

#### 2. CHECK HARNESS FOR OPEN CIRCUIT

1. Disconnect the connector of combination meter.
2. Check the resistance between the combination meter harness connector terminals.

| Combination meter harness connector |              |    | Resistance (Ω)  |
|-------------------------------------|--------------|----|-----------------|
| Connector No.                       | Terminal No. |    |                 |
| M24                                 | 21           | 22 | Approx. 54 – 66 |

Is the measurement value within the specification?

- YES >> GO TO 3.  
NO >> Repair the combination meter branch line.

#### 3. CHECK POWER SUPPLY AND GROUND CIRCUIT

Check the power supply and the ground circuit of the combination meter. Refer to [MWI-37, "COMBINATION METER : Diagnosis Procedure"](#).

Is the inspection result normal?

- YES (Present error)>>Replace the combination meter. Refer to [MWI-121, "Removal and Installation"](#).  
YES (Past error)>>Error was detected in the combination meter branch line.  
NO >> Repair the power supply and the ground circuit.

A  
B  
C  
D  
E  
F  
G  
H  
I  
J  
K  
L  
N  
O  
P

LAN

# AV BRANCH LINE CIRCUIT

< DTC/CIRCUIT DIAGNOSIS >

[CAN]

## AV BRANCH LINE CIRCUIT

### Diagnosis Procedure

INFOID:000000008634508

#### 1. CHECK CONNECTOR

1. Turn the ignition switch OFF.
2. Disconnect the battery cable from the negative terminal.
3. Check the terminals and connectors of the AV control unit for damage, bend and loose connection (unit side and connector side).

Is the inspection result normal?

- YES >> GO TO 2.  
NO >> Repair the terminal and connector.

#### 2. CHECK HARNESS FOR OPEN CIRCUIT

1. Disconnect the connector of AV control unit.
  2. Check the resistance between the AV control unit harness connector terminals.
- Models without navigation system

| AV control unit harness connector |              |    | Resistance (Ω)  |
|-----------------------------------|--------------|----|-----------------|
| Connector No.                     | Terminal No. |    |                 |
| M156                              | 86           | 87 | Approx. 54 – 66 |

- Models with navigation system

| AV control unit harness connector |              |    | Resistance (Ω)  |
|-----------------------------------|--------------|----|-----------------|
| Connector No.                     | Terminal No. |    |                 |
| M163                              | 62           | 46 | Approx. 54 – 66 |

Is the measurement value within the specification?

- YES >> GO TO 3.  
NO >> Repair the AV control unit branch line.

#### 3. CHECK POWER SUPPLY AND GROUND CIRCUIT

Check the power supply and the ground circuit of the AV control unit. Refer to the following.

- Models with BOSE audio with color display: [AV-240, "AV CONTROL UNIT : Diagnosis Procedure"](#)
- Models with BOSE audio with color display with navigation system: [AV-424, "AV CONTROL UNIT : Diagnosis Procedure"](#)

Is the inspection result normal?

- YES (Present error)>>Replace the AV control unit. Refer to the following.
- Models with BOSE audio with color display: [AV-334, "Removal and Installation"](#)
  - Models with BOSE audio with color display with navigation system: [AV-505, "Removal and Installation"](#)

YES (Past error)>>Error was detected in the AV control unit branch line.

- NO >> Repair the power supply and the ground circuit.



# HVAC BRANCH LINE CIRCUIT

< DTC/CIRCUIT DIAGNOSIS >

[CAN]

## HVAC BRANCH LINE CIRCUIT

### Diagnosis Procedure

INFOID:000000008634509

#### 1. CHECK CONNECTOR

1. Turn the ignition switch OFF.
2. Disconnect the battery cable from the negative terminal.
3. Check the terminals and connectors of the A/C auto amp. for damage, bend and loose connection (unit side and connector side).

Is the inspection result normal?

- YES >> GO TO 2.  
NO >> Repair the terminal and connector.

#### 2. CHECK HARNESS FOR OPEN CIRCUIT

1. Disconnect the connector of A/C auto amp.
2. Check the resistance between the A/C auto amp. harness connector terminals.

| A/C auto amp. harness connector |              |   | Resistance (Ω)  |
|---------------------------------|--------------|---|-----------------|
| Connector No.                   | Terminal No. |   |                 |
| M37                             | 1            | 2 | Approx. 54 – 66 |

Is the measurement value within the specification?

- YES >> GO TO 3.  
NO >> Repair the A/C auto amp. branch line.

#### 3. CHECK POWER SUPPLY AND GROUND CIRCUIT

Check the power supply and the ground circuit of the A/C auto amp. Refer to the following.

- Models with color display: [HAC-60, "A/C AUTO AMP. : Diagnosis Procedure"](#)
- Models with monochrome display: [HAC-164, "A/C AUTO AMP. : Diagnosis Procedure"](#)

Is the inspection result normal?

- YES (Present error)>>Replace the A/C auto amp. Refer to the following.
- Models with color display: [HAC-99, "Removal and Installation"](#)
  - Models monochrome display: [HAC-203, "Removal and Installation"](#)

YES (Past error)>>Error was detected in the A/C auto amp. branch line.

NO >> Repair the power supply and the ground circuit.

A  
B  
C  
D  
E  
F  
G  
H  
I  
J  
K  
L

LAN

N  
O  
P

# STRG BRANCH LINE CIRCUIT

< DTC/CIRCUIT DIAGNOSIS >

[CAN]

## STRG BRANCH LINE CIRCUIT

### Diagnosis Procedure

INFOID:000000008634510

#### 1. CHECK CONNECTOR

1. Turn the ignition switch OFF.
2. Disconnect the battery cable from the negative terminal.
3. Check the terminals and connectors of the steering angle sensor for damage, bend and loose connection (unit side and connector side).

Is the inspection result normal?

- YES >> GO TO 2.  
NO >> Repair the terminal and connector.

#### 2. CHECK HARNESS FOR OPEN CIRCUIT

1. Disconnect the connector of steering angle sensor.
2. Check the resistance between the steering angle sensor harness connector terminals.

| Steering angle sensor harness connector |              |   | Resistance ( $\Omega$ ) |
|---|--------------|---|-------------------------|
| Connector No.                           | Terminal No. |   |                         |
| M53                                     | 5            | 2 | Approx. 54 – 66         |

Is the measurement value within the specification?

- YES >> GO TO 3.  
NO >> Repair the steering angle sensor branch line.

#### 3. CHECK POWER SUPPLY AND GROUND CIRCUIT

Check the power supply and the ground circuit of the steering angle sensor. Refer to [BRC-83, "Wiring Diagram"](#).

Is the inspection result normal?

- YES (Present error)>>Replace the steering angle sensor. Refer to [BRC-109, "Removal and Installation"](#).  
YES (Past error)>>Error was detected in the steering angle sensor branch line.  
NO >> Repair the power supply and the ground circuit.

# A-BAG BRANCH LINE CIRCUIT

< DTC/CIRCUIT DIAGNOSIS >

[CAN]

## A-BAG BRANCH LINE CIRCUIT

### Diagnosis Procedure

INFOID:000000008634511

#### **WARNING:**

Always observe the following items for preventing accidental activation.

- Before servicing, turn ignition switch OFF, disconnect battery negative terminal, and wait 3 minutes or more. (To discharge backup capacitor.)
- Never use unspecified tester or other measuring device.

#### **1**.CHECK CONNECTOR

1. Turn the ignition switch OFF.
2. Disconnect the battery cable from the negative terminal.
3. Check the terminals and connectors of the air bag diagnosis sensor unit for damage, bend and loose connection (unit side and connector side).

Is the inspection result normal?

YES >> GO TO 2.

NO >> Replace the main harness.

#### **2**.CHECK AIR BAG DIAGNOSIS SENSOR UNIT

Check the air bag diagnosis sensor unit. Refer to [SRC-3. "Work Flow"](#).

Is the inspection result normal?

YES >> Replace the main harness.

NO >> Replace parts whose air bag system has a malfunction.

A  
B  
C  
D  
E  
F  
G  
H  
I  
J  
K  
L  
N  
O  
P

LAN

# ABS BRANCH LINE CIRCUIT

< DTC/CIRCUIT DIAGNOSIS >

[CAN]

## ABS BRANCH LINE CIRCUIT

### Diagnosis Procedure

INFOID:000000008634512

#### 1. CHECK CONNECTOR

1. Turn the ignition switch OFF.
2. Disconnect the battery cable from the negative terminal.
3. Check the terminals and connectors of the ABS actuator and electric unit (control unit) for damage, bend and loose connection (unit side and connector side).

Is the inspection result normal?

- YES >> GO TO 2.  
NO >> Repair the terminal and connector.

#### 2. CHECK HARNESS FOR OPEN CIRCUIT

1. Disconnect the connector of ABS actuator and electric unit (control unit).
2. Check the resistance between the ABS actuator and electric unit (control unit) harness connector terminals.

| ABS actuator and electric unit (control unit) harness connector |              |    | Resistance (Ω)  |
|---|--------------|----|-----------------|
| Connector No.   | Terminal No. |    |                 |
| E26   | 26           | 15 | Approx. 54 – 66 |

Is the measurement value within the specification?

- YES >> GO TO 3.  
NO >> Repair the ABS actuator and electric unit (control unit) branch line.

#### 3. CHECK POWER SUPPLY AND GROUND CIRCUIT

Check the power supply and the ground circuit of the ABS actuator and electric unit (control unit). Refer to [BRC-83. "Wiring Diagram"](#).

Is the inspection result normal?

- YES (Present error)>>Replace the ABS actuator and electric unit (control unit). Refer to [BRC-106. "Exploded View"](#).  
YES (Past error)>>Error was detected in the ABS actuator and electric unit (control unit) branch line.  
NO >> Repair the power supply and the ground circuit.

# TCM BRANCH LINE CIRCUIT

< DTC/CIRCUIT DIAGNOSIS >

[CAN]

## TCM BRANCH LINE CIRCUIT

### Diagnosis Procedure

INFOID:000000008634513

#### 1.CHECK CONNECTOR

1. Turn the ignition switch OFF.
2. Disconnect the battery cable from the negative terminal.
3. Check the following terminals and connectors for damage, bend and loose connection (unit side and connector side).
  - TCM
  - Harness connector F1
  - Harness connector E3

Is the inspection result normal?

YES >> GO TO 2.

NO >> Repair the terminal and connector.

#### 2.CHECK HARNESS FOR OPEN CIRCUIT

1. Disconnect the connector of TCM.
2. Check the resistance between the TCM harness connector terminals.

| TCM harness connector |              |    | Resistance (Ω)  |
|-----------------------|--------------|----|-----------------|
| Connector No.         | Terminal No. |    |                 |
| F15                   | 32           | 31 | Approx. 54 – 66 |

Is the measurement value within the specification?

YES >> GO TO 3.

NO >> Repair the TCM branch line.

#### 3.CHECK POWER SUPPLY AND GROUND CIRCUIT

Check the power supply and the ground circuit of the TCM. Refer to [TM-124, "Wiring Diagram"](#).

Is the inspection result normal?

YES (Present error)>>Replace the TCM. Refer to [TM-166, "Exploded View"](#).

YES (Past error)>>Error was detected in the TCM branch line.

NO >> Repair the power supply and the ground circuit.

A  
B  
C  
D  
E  
F  
G  
H  
I  
J  
K  
L

LAN

# IPDM-E BRANCH LINE CIRCUIT

< DTC/CIRCUIT DIAGNOSIS >

[CAN]

## IPDM-E BRANCH LINE CIRCUIT

### Diagnosis Procedure

INFOID:000000008634514

#### 1. CHECK CONNECTOR

1. Turn the ignition switch OFF.
2. Disconnect the battery cable from the negative terminal.
3. Check the terminals and connectors of the IPDM E/R for damage, bend and loose connection (unit side and connector side).

Is the inspection result normal?

- YES >> GO TO 2.  
NO >> Repair the terminal and connector.

#### 2. CHECK HARNESS FOR OPEN CIRCUIT

1. Disconnect the connector of IPDM E/R.
2. Check the resistance between the IPDM E/R harness connector terminals.

| IPDM E/R harness connector |              |    | Resistance ( $\Omega$ ) |
|----------------------------|--------------|----|-------------------------|
| Connector No.              | Terminal No. |    |                         |
| E17                        | 40           | 39 | Approx. 108 – 132       |

Is the measurement value within the specification?

- YES >> GO TO 3.  
NO >> Repair the IPDM E/R branch line.

#### 3. CHECK POWER SUPPLY AND GROUND CIRCUIT

Check the power supply and the ground circuit of the IPDM E/R. Refer to [PCS-18, "Diagnosis Procedure"](#).

Is the inspection result normal?

- YES (Present error)>>Replace the IPDM E/R. Refer to [PCS-35, "Removal and Installation"](#).  
YES (Past error)>>Error was detected in the IPDM E/R branch line.  
NO >> Repair the power supply and the ground circuit.

# CAN COMMUNICATION CIRCUIT

< DTC/CIRCUIT DIAGNOSIS >

[CAN]

## CAN COMMUNICATION CIRCUIT

### Diagnosis Procedure

INFOID:000000008634515

#### 1. CONNECTOR INSPECTION

1. Turn the ignition switch OFF.
2. Disconnect the battery cable from the negative terminal.
3. Disconnect all the unit connectors on CAN communication system.
4. Check terminals and connectors for damage, bend and loose connection.

Is the inspection result normal?

- YES >> GO TO 2.  
NO >> Repair the terminal and connector.

#### 2. CHECK HARNESS CONTINUITY (SHORT CIRCUIT)

Check the continuity between the data link connector terminals.

| Data link connector |              | Continuity  |
|---------------------|--------------|-------------|
| Connector No.       | Terminal No. |             |
| M22                 | 6 14         | Not existed |

Is the inspection result normal?

- YES >> GO TO 3.  
NO >> Check the harness and repair the root cause.

#### 3. CHECK HARNESS CONTINUITY (SHORT CIRCUIT)

Check the continuity between the data link connector and the ground.

| Data link connector |              | Ground | Continuity  |
|---------------------|--------------|--------|-------------|
| Connector No.       | Terminal No. |        |             |
| M22                 | 6            |        | Not existed |
|                     | 14           |        | Not existed |

Is the inspection result normal?

- YES >> GO TO 4.  
NO >> Check the harness and repair the root cause.

#### 4. CHECK ECM AND IPDM E/R TERMINATION CIRCUIT

1. Remove the ECM and the IPDM E/R.
2. Check the resistance between the ECM terminals.

| ECM          |    | Resistance ( $\Omega$ ) |
|--------------|----|-------------------------|
| Terminal No. |    |                         |
| 98           | 97 | Approx. 108 – 132       |

3. Check the resistance between the IPDM E/R terminals.

| IPDM E/R     |    | Resistance ( $\Omega$ ) |
|--------------|----|-------------------------|
| Terminal No. |    |                         |
| 40           | 39 | Approx. 108 – 132       |

Is the measurement value within the specification?

- YES >> GO TO 5.  
NO >> Replace the ECM and/or the IPDM E/R.

#### 5. CHECK SYMPTOM

Connect all the connectors. Check if the symptoms described in the "Symptom (Results from interview with customer)" are reproduced.

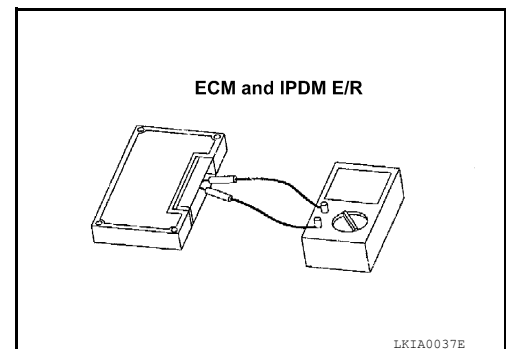

## CAN COMMUNICATION CIRCUIT

< DTC/CIRCUIT DIAGNOSIS >

[CAN]

---

### Inspection result

Reproduced>>GO TO 6.

Non-reproduced>>Start the diagnosis again. Follow the trouble diagnosis procedure when past error is detected.

## 6.CHECK UNIT REPRODUCTION

---

Perform the reproduction test as per the following procedure for each unit.

1. Turn the ignition switch OFF.
2. Disconnect the battery cable from the negative terminal.
3. Disconnect one of the unit connectors of CAN communication system.

**NOTE:**

ECM and IPDM E/R have a termination circuit. Check other units first.

4. Connect the battery cable to the negative terminal. Check if the symptoms described in the "Symptom (Results from interview with customer)" are reproduced.

**NOTE:**

Although unit-related error symptoms occur, do not confuse them with other symptoms.

### Inspection result

Reproduced>>Connect the connector. Check other units as per the above procedure.

Non-reproduced>>Replace the unit whose connector was disconnected.



# MAIN LINE BETWEEN DLC AND HVAC CIRCUIT

< DTC/CIRCUIT DIAGNOSIS >

[CAN SYSTEM (TYPE 1)]

## DTC/CIRCUIT DIAGNOSIS

### MAIN LINE BETWEEN DLC AND HVAC CIRCUIT

#### Diagnosis Procedure

INFOID:000000008839094

#### 1. CHECK HARNESS CONTINUITY (OPEN CIRCUIT)

1. Turn the ignition switch OFF.
2. Disconnect the battery cable from the negative terminal.
3. Disconnect the following harness connectors.
  - ECM
  - A/C auto amp.
4. Check the continuity between the data link connector and the A/C auto amp. harness connector.

| Data link connector |              | A/C auto amp. harness connector |              | Continuity |
|---------------------|--------------|---------------------------------|--------------|------------|
| Connector No.       | Terminal No. | Connector No.                   | Terminal No. |            |
| M22                 | 6            | M37                             | 1            | Existed    |
|                     | 14           |                                 | 2            | Existed    |

#### Is the inspection result normal?

YES (Present error)>>Check CAN system type decision again.

YES (Past error)>>Error was detected in the main line between the data link connector and the A/C auto amp.

NO >> Repair the main line between the data link connector and the A/C auto amp.

A  
B  
C  
D  
E  
F  
G  
H  
I  
J  
K  
L  
N  
O  
P

LAN

# MAIN LINE BETWEEN HVAC AND A-BAG CIRCUIT

< DTC/CIRCUIT DIAGNOSIS >

[CAN SYSTEM (TYPE 1)]

## MAIN LINE BETWEEN HVAC AND A-BAG CIRCUIT

### Diagnosis Procedure

INFOID:000000008839096

#### 1. CHECK HARNESS CONTINUITY (OPEN CIRCUIT)

1. Turn the ignition switch OFF.
2. Disconnect the battery cable from the negative terminal.
3. Disconnect the following harness connectors.
  - A/C auto amp.
  - Harness connectors M1 and E30
4. Check the continuity between the harness connector and the A/C auto amp. harness connector.

| A/C auto amp. harness connector |              | Harness connector |              | Continuity |
|---------------------------------|--------------|-------------------|--------------|------------|
| Connector No.                   | Terminal No. | Connector No.     | Terminal No. |            |
| M37                             | 1            | M1                | 15G          | Existed    |
|                                 | 2            |                   | 8G           | Existed    |

#### Is the inspection result normal?

YES (Present error)>>Check CAN system type decision again.

YES (Past error)>>Error was detected in the main line between the A/C auto amp. and the air bag diagnosis sensor unit.

NO >> Repair the main line between the A/C auto amp. and the air bag diagnosis sensor unit.

# MAIN LINE BETWEEN A-BAG AND ABS CIRCUIT

< DTC/CIRCUIT DIAGNOSIS >

[CAN SYSTEM (TYPE 1)]

## MAIN LINE BETWEEN A-BAG AND ABS CIRCUIT

### Diagnosis Procedure

INFOID:000000008839097

#### 1.CHECK CONNECTOR

1. Turn the ignition switch OFF.
2. Disconnect the battery cable from the negative terminal.
3. Check the following terminals and connectors for damage, bend and loose connection (connector side and harness side).
  - Harness connector M1
  - Harness connector E30

Is the inspection result normal?

YES >> GO TO 2.

NO >> Repair the terminal and connector.

#### 2.CHECK HARNESS CONTINUITY (OPEN CIRCUIT)

1. Disconnect the following harness connectors.
  - A/C auto amp.
  - Harness connectors M1 and E30
2. Check the continuity between the A/C auto amp. harness connector and the harness connector.

| A/C auto amp. harness connector |              | Harness connector |              | Continuity |
|---------------------------------|--------------|-------------------|--------------|------------|
| Connector No.                   | Terminal No. | Connector No.     | Terminal No. |            |
| M37                             | 1            | M1                | 15G          | Existed    |
|                                 | 2            |                   | 8G           | Existed    |

Is the inspection result normal?

YES >> GO TO 3.

NO >> Repair the main line between the air bag diagnosis sensor unit and the harness connector M1.

#### 3.CHECK HARNESS CONTINUITY (OPEN CIRCUIT)

1. Disconnect the connector of ABS actuator and electric unit (control unit).
2. Check the continuity between the harness connector and the ABS actuator and electric unit (control unit) harness connector.

| Harness connector |              | ABS actuator and electric unit (control unit) harness connector |              | Continuity |
|-------------------|--------------|---|--------------|------------|
| Connector No.     | Terminal No. | Connector No.   | Terminal No. |            |
| E30               | 15G          | E26   | 26           | Existed    |
|                   | 8G           |   | 15           | Existed    |

Is the inspection result normal?

YES (Present error)>>Check CAN system type decision again.

YES (Past error)>>Error was detected in the main line between the air bag diagnosis sensor unit and the ABS actuator and electric unit (control unit).

NO >> Repair the main line between the harness connector E30 and the ABS actuator and electric unit (control unit).

# ECM BRANCH LINE CIRCUIT

< DTC/CIRCUIT DIAGNOSIS >

[CAN SYSTEM (TYPE 1)]

## ECM BRANCH LINE CIRCUIT

### Diagnosis Procedure

INFOID:000000008839098

#### 1. CHECK CONNECTOR

1. Turn the ignition switch OFF.
2. Disconnect the battery cable from the negative terminal.
3. Check the following terminals and connectors for damage, bend and loose connection (unit side and connector side).
  - Models without automatic drive positioner
    - ECM
    - Harness connector E30
    - Harness connector M1
  - Models with automatic drive positioner
    - ECM
    - Harness connector E29
    - Harness connector B10

Is the inspection result normal?

YES >> GO TO 2.

NO >> Repair the terminal and connector.

#### 2. CHECK HARNESS FOR OPEN CIRCUIT

1. Disconnect the connector of ECM.
2. Check the resistance between the ECM harness connector terminals.

| ECM harness connector |              | Resistance ( $\Omega$ ) |
|-----------------------|--------------|-------------------------|
| Connector No.         | Terminal No. |                         |
| E10                   | 98           | Approx. 108 – 132       |
|                       | 97           |                         |

Is the measurement value within the specification?

YES >> GO TO 3.

NO >> Repair the ECM branch line.

#### 3. CHECK POWER SUPPLY AND GROUND CIRCUIT

Check the power supply and the ground circuit of the ECM. Refer to [EC-155, "Diagnosis Procedure"](#).

Is the inspection result normal?

YES (Present error)>>Replace the ECM. Refer to [EC-17, "ADDITIONAL SERVICE WHEN REPLACING CONTROL UNIT : Description"](#).

YES (Past error)>>Error was detected in the ECM branch line.

NO >> Repair the power supply and the ground circuit.

# BCM BRANCH LINE CIRCUIT

< DTC/CIRCUIT DIAGNOSIS >

[CAN SYSTEM (TYPE 1)]

## BCM BRANCH LINE CIRCUIT

### Diagnosis Procedure

INFOID:000000008839100

#### 1. CHECK CONNECTOR

1. Turn the ignition switch OFF.
2. Disconnect the battery cable from the negative terminal.
3. Check the terminals and connectors of the BCM for damage, bend and loose connection (unit side and connector side).

Is the inspection result normal?

- YES >> GO TO 2.  
NO >> Repair the terminal and connector.

#### 2. CHECK HARNESS FOR OPEN CIRCUIT

1. Disconnect the connector of BCM.
2. Check the resistance between the BCM harness connector terminals.

| BCM harness connector |              |    | Resistance ( $\Omega$ ) |
|-----------------------|--------------|----|-------------------------|
| Connector No.         | Terminal No. |    |                         |
| M19                   | 79           | 78 | Approx. 54 – 66         |

Is the measurement value within the specification?

- YES >> GO TO 3.  
NO >> Repair the BCM branch line.

#### 3. CHECK POWER SUPPLY AND GROUND CIRCUIT

Check the power supply and the ground circuit of the BCM. Refer to [BCS-36, "Diagnosis Procedure"](#).

Is the inspection result normal?

- YES (Present error)>>Replace the BCM. Refer to [BCS-79, "Removal and Installation"](#).  
YES (Past error)>>Error was detected in the BCM branch line.  
NO >> Repair the power supply and the ground circuit.

A  
B  
C  
D  
E  
F  
G  
H  
I  
J  
K  
L

LAN

# DLC BRANCH LINE CIRCUIT

< DTC/CIRCUIT DIAGNOSIS >

[CAN SYSTEM (TYPE 1)]

## DLC BRANCH LINE CIRCUIT

### Diagnosis Procedure

INFOID:000000008839101

#### 1. CHECK CONNECTOR

1. Turn the ignition switch OFF.
2. Disconnect the battery cable from the negative terminal.
3. Check the terminals and connectors of the data link connector for damage, bend and loose connection (connector side and harness side).

Is the inspection result normal?

- YES >> GO TO 2.  
NO >> Repair the terminal and connector.

#### 2. CHECK HARNESS FOR OPEN CIRCUIT

Check the resistance between the data link connector terminals.

| Data link connector |              |    | Resistance ( $\Omega$ ) |
|---------------------|--------------|----|-------------------------|
| Connector No.       | Terminal No. |    |                         |
| M22                 | 6            | 14 | Approx. 54 – 66         |

Is the measurement value within the specification?

- YES (Present error)>>Check CAN system type decision again.  
YES (Past error)>>Error was detected in the data link connector branch line circuit.  
NO >> Repair the data link connector branch line.

# M&A BRANCH LINE CIRCUIT

< DTC/CIRCUIT DIAGNOSIS >

[CAN SYSTEM (TYPE 1)]

## M&A BRANCH LINE CIRCUIT

### Diagnosis Procedure

INFOID:000000008839102

#### 1. CHECK CONNECTOR

1. Turn the ignition switch OFF.
2. Disconnect the battery cable from the negative terminal.
3. Check the terminals and connectors of the combination meter for damage, bend and loose connection (unit side and connector side).

Is the inspection result normal?

- YES >> GO TO 2.  
NO >> Repair the terminal and connector.

#### 2. CHECK HARNESS FOR OPEN CIRCUIT

1. Disconnect the connector of combination meter.
2. Check the resistance between the combination meter harness connector terminals.

| Combination meter harness connector |              |    | Resistance ( $\Omega$ ) |
|-------------------------------------|--------------|----|-------------------------|
| Connector No.                       | Terminal No. |    |                         |
| M24                                 | 21           | 22 | Approx. 54 – 66         |

Is the measurement value within the specification?

- YES >> GO TO 3.  
NO >> Repair the combination meter branch line.

#### 3. CHECK POWER SUPPLY AND GROUND CIRCUIT

Check the power supply and the ground circuit of the combination meter. Refer to [MWI-37, "COMBINATION METER : Diagnosis Procedure"](#).

Is the inspection result normal?

- YES (Present error)>>Replace the combination meter. Refer to [MWI-121, "Removal and Installation"](#).  
YES (Past error)>>Error was detected in the combination meter branch line.  
NO >> Repair the power supply and the ground circuit.

A  
B  
C  
D  
E  
F  
G  
H  
I  
J  
K  
L  
N  
O  
P

LAN

# HVAC BRANCH LINE CIRCUIT

< DTC/CIRCUIT DIAGNOSIS >

[CAN SYSTEM (TYPE 1)]

## HVAC BRANCH LINE CIRCUIT

### Diagnosis Procedure

INFOID:000000008839104

#### 1. CHECK CONNECTOR

1. Turn the ignition switch OFF.
2. Disconnect the battery cable from the negative terminal.
3. Check the terminals and connectors of the A/C auto amp. for damage, bend and loose connection (unit side and connector side).

Is the inspection result normal?

- YES >> GO TO 2.  
NO >> Repair the terminal and connector.

#### 2. CHECK HARNESS FOR OPEN CIRCUIT

1. Disconnect the connector of A/C auto amp.
2. Check the resistance between the A/C auto amp. harness connector terminals.

| A/C auto amp. harness connector |              |   | Resistance ( $\Omega$ ) |
|---------------------------------|--------------|---|-------------------------|
| Connector No.                   | Terminal No. |   |                         |
| M37                             | 1            | 2 | Approx. 54 – 66         |

Is the measurement value within the specification?

- YES >> GO TO 3.  
NO >> Repair the A/C auto amp. branch line.

#### 3. CHECK POWER SUPPLY AND GROUND CIRCUIT

Check the power supply and the ground circuit of the A/C auto amp. Refer to the following.

- Models with color display: [HAC-60, "A/C AUTO AMP. : Diagnosis Procedure"](#)
- Models with monochrome display: [HAC-164, "A/C AUTO AMP. : Diagnosis Procedure"](#)

Is the inspection result normal?

- YES (Present error)>>Replace the A/C auto amp. Refer to the following.
- Models with color display: [HAC-99, "Removal and Installation"](#)
  - Models monochrome display: [HAC-203, "Removal and Installation"](#)
- YES (Past error)>>Error was detected in the A/C auto amp. branch line.  
NO >> Repair the power supply and the ground circuit.



# STRG BRANCH LINE CIRCUIT

< DTC/CIRCUIT DIAGNOSIS >

[CAN SYSTEM (TYPE 1)]

## STRG BRANCH LINE CIRCUIT

### Diagnosis Procedure

INFOID:000000008839105

#### 1. CHECK CONNECTOR

1. Turn the ignition switch OFF.
2. Disconnect the battery cable from the negative terminal.
3. Check the terminals and connectors of the steering angle sensor for damage, bend and loose connection (unit side and connector side).

Is the inspection result normal?

- YES >> GO TO 2.  
NO >> Repair the terminal and connector.

#### 2. CHECK HARNESS FOR OPEN CIRCUIT

1. Disconnect the connector of steering angle sensor.
2. Check the resistance between the steering angle sensor harness connector terminals.

| Steering angle sensor harness connector |              |   | Resistance ( $\Omega$ ) |
|---|--------------|---|-------------------------|
| Connector No.                           | Terminal No. |   |                         |
| M53                                     | 5            | 2 | Approx. 54 – 66         |

Is the measurement value within the specification?

- YES >> GO TO 3.  
NO >> Repair the steering angle sensor branch line.

#### 3. CHECK POWER SUPPLY AND GROUND CIRCUIT

Check the power supply and the ground circuit of the steering angle sensor. Refer to [BRC-83, "Wiring Diagram"](#).

Is the inspection result normal?

- YES (Present error)>>Replace the steering angle sensor. Refer to [BRC-109, "Removal and Installation"](#).  
YES (Past error)>>Error was detected in the steering angle sensor branch line.  
NO >> Repair the power supply and the ground circuit.

A  
B  
C  
D  
E  
F  
G  
H  
I  
J  
K  
L

LAN

# A-BAG BRANCH LINE CIRCUIT

< DTC/CIRCUIT DIAGNOSIS >

[CAN SYSTEM (TYPE 1)]

## A-BAG BRANCH LINE CIRCUIT

### Diagnosis Procedure

INFOID:000000008839106

#### **WARNING:**

Always observe the following items for preventing accidental activation.

- Before servicing, turn ignition switch OFF, disconnect battery negative terminal, and wait 3 minutes or more. (To discharge backup capacitor.)
- Never use unspecified tester or other measuring device.

#### **1**.CHECK CONNECTOR

1. Turn the ignition switch OFF.
2. Disconnect the battery cable from the negative terminal.
3. Check the terminals and connectors of the air bag diagnosis sensor unit for damage, bend and loose connection (unit side and connector side).

Is the inspection result normal?

- YES >> GO TO 2.  
NO >> Replace the main harness.

#### **2**.CHECK AIR BAG DIAGNOSIS SENSOR UNIT

Check the air bag diagnosis sensor unit. Refer to [SRC-3. "Work Flow"](#).

Is the inspection result normal?

- YES >> Replace the main harness.  
NO >> Replace parts whose air bag system has a malfunction.

# ABS BRANCH LINE CIRCUIT

< DTC/CIRCUIT DIAGNOSIS >

[CAN SYSTEM (TYPE 1)]

## ABS BRANCH LINE CIRCUIT

### Diagnosis Procedure

INFOID:000000008839107

#### 1. CHECK CONNECTOR

1. Turn the ignition switch OFF.
2. Disconnect the battery cable from the negative terminal.
3. Check the terminals and connectors of the ABS actuator and electric unit (control unit) for damage, bend and loose connection (unit side and connector side).

Is the inspection result normal?

- YES >> GO TO 2.  
NO >> Repair the terminal and connector.

#### 2. CHECK HARNESS FOR OPEN CIRCUIT

1. Disconnect the connector of ABS actuator and electric unit (control unit).
2. Check the resistance between the ABS actuator and electric unit (control unit) harness connector terminals.

| ABS actuator and electric unit (control unit) harness connector |              |    | Resistance (Ω)  |
|---|--------------|----|-----------------|
| Connector No.   | Terminal No. |    |                 |
| E26   | 26           | 15 | Approx. 54 – 66 |

Is the measurement value within the specification?

- YES >> GO TO 3.  
NO >> Repair the ABS actuator and electric unit (control unit) branch line.

#### 3. CHECK POWER SUPPLY AND GROUND CIRCUIT

Check the power supply and the ground circuit of the ABS actuator and electric unit (control unit). Refer to [BRC-83, "Wiring Diagram"](#).

Is the inspection result normal?

- YES (Present error)>>Replace the ABS actuator and electric unit (control unit). Refer to [BRC-106, "Exploded View"](#).  
YES (Past error)>>Error was detected in the ABS actuator and electric unit (control unit) branch line.  
NO >> Repair the power supply and the ground circuit.

A  
B  
C  
D  
E  
F  
G  
H  
I  
J  
K  
L

LAN

# TCM BRANCH LINE CIRCUIT

< DTC/CIRCUIT DIAGNOSIS >

[CAN SYSTEM (TYPE 1)]

## TCM BRANCH LINE CIRCUIT

### Diagnosis Procedure

INFOID:000000008839108

#### 1. CHECK CONNECTOR

1. Turn the ignition switch OFF.
2. Disconnect the battery cable from the negative terminal.
3. Check the following terminals and connectors for damage, bend and loose connection (unit side and connector side).
  - TCM
  - Harness connector F1
  - Harness connector E3

Is the inspection result normal?

YES >> GO TO 2.

NO >> Repair the terminal and connector.

#### 2. CHECK HARNESS FOR OPEN CIRCUIT

1. Disconnect the connector of TCM.
2. Check the resistance between the TCM harness connector terminals.

| TCM harness connector |              |    | Resistance ( $\Omega$ ) |
|-----------------------|--------------|----|-------------------------|
| Connector No.         | Terminal No. |    |                         |
| F15                   | 32           | 31 | Approx. 54 – 66         |

Is the measurement value within the specification?

YES >> GO TO 3.

NO >> Repair the TCM branch line.

#### 3. CHECK POWER SUPPLY AND GROUND CIRCUIT

Check the power supply and the ground circuit of the TCM. Refer to [TM-124, "Wiring Diagram"](#).

Is the inspection result normal?

YES (Present error)>>Replace the TCM. Refer to [TM-166, "Exploded View"](#).

YES (Past error)>>Error was detected in the TCM branch line.

NO >> Repair the power supply and the ground circuit.

# IPDM-E BRANCH LINE CIRCUIT

< DTC/CIRCUIT DIAGNOSIS >

[CAN SYSTEM (TYPE 1)]

## IPDM-E BRANCH LINE CIRCUIT

### Diagnosis Procedure

INFOID:000000008839109

#### 1.CHECK CONNECTOR

1. Turn the ignition switch OFF.
2. Disconnect the battery cable from the negative terminal.
3. Check the terminals and connectors of the IPDM E/R for damage, bend and loose connection (unit side and connector side).

Is the inspection result normal?

- YES >> GO TO 2.  
NO >> Repair the terminal and connector.

#### 2.CHECK HARNESS FOR OPEN CIRCUIT

1. Disconnect the connector of IPDM E/R.
2. Check the resistance between the IPDM E/R harness connector terminals.

| IPDM E/R harness connector |              |    | Resistance (Ω)    |
|----------------------------|--------------|----|-------------------|
| Connector No.              | Terminal No. |    |                   |
| E17                        | 40           | 39 | Approx. 108 – 132 |

Is the measurement value within the specification?

- YES >> GO TO 3.  
NO >> Repair the IPDM E/R branch line.

#### 3.CHECK POWER SUPPLY AND GROUND CIRCUIT

Check the power supply and the ground circuit of the IPDM E/R. Refer to [PCS-18. "Diagnosis Procedure"](#).

Is the inspection result normal?

- YES (Present error)>>Replace the IPDM E/R. Refer to [PCS-35. "Removal and Installation"](#).  
YES (Past error)>>Error was detected in the IPDM E/R branch line.  
NO >> Repair the power supply and the ground circuit.

A  
B  
C  
D  
E  
F  
G  
H  
I  
J  
K  
L

LAN

# CAN COMMUNICATION CIRCUIT

< DTC/CIRCUIT DIAGNOSIS >

[CAN SYSTEM (TYPE 1)]

## CAN COMMUNICATION CIRCUIT

### Diagnosis Procedure

INFOID:000000008839110

#### 1. CONNECTOR INSPECTION

1. Turn the ignition switch OFF.
2. Disconnect the battery cable from the negative terminal.
3. Disconnect all the unit connectors on CAN communication system.
4. Check terminals and connectors for damage, bend and loose connection.

Is the inspection result normal?

- YES >> GO TO 2.  
NO >> Repair the terminal and connector.

#### 2. CHECK HARNESS CONTINUITY (SHORT CIRCUIT)

Check the continuity between the data link connector terminals.

| Data link connector |              | Continuity  |
|---------------------|--------------|-------------|
| Connector No.       | Terminal No. |             |
| M22                 | 6 14         | Not existed |

Is the inspection result normal?

- YES >> GO TO 3.  
NO >> Check the harness and repair the root cause.

#### 3. CHECK HARNESS CONTINUITY (SHORT CIRCUIT)

Check the continuity between the data link connector and the ground.

| Data link connector |              | Ground | Continuity  |
|---------------------|--------------|--------|-------------|
| Connector No.       | Terminal No. |        |             |
| M22                 | 6            |        | Not existed |
|                     | 14           |        | Not existed |

Is the inspection result normal?

- YES >> GO TO 4.  
NO >> Check the harness and repair the root cause.

#### 4. CHECK ECM AND IPDM E/R TERMINATION CIRCUIT

1. Remove the ECM and the IPDM E/R.
2. Check the resistance between the ECM terminals.

| ECM          |    | Resistance ( $\Omega$ ) |
|--------------|----|-------------------------|
| Terminal No. |    |                         |
| 98           | 97 | Approx. 108 – 132       |

3. Check the resistance between the IPDM E/R terminals.

| IPDM E/R     |    | Resistance ( $\Omega$ ) |
|--------------|----|-------------------------|
| Terminal No. |    |                         |
| 40           | 39 | Approx. 108 – 132       |

Is the measurement value within the specification?

- YES >> GO TO 5.  
NO >> Replace the ECM and/or the IPDM E/R.

#### 5. CHECK SYMPTOM

Connect all the connectors. Check if the symptoms described in the "Symptom (Results from interview with customer)" are reproduced.

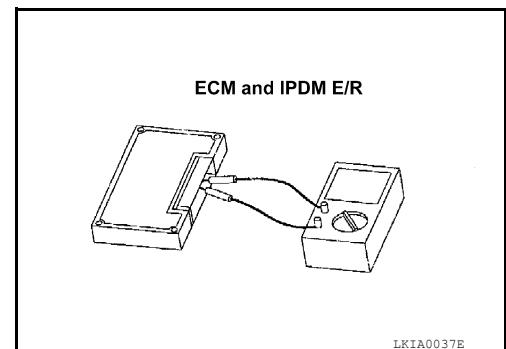

# CAN COMMUNICATION CIRCUIT

< DTC/CIRCUIT DIAGNOSIS >

[CAN SYSTEM (TYPE 1)]

## Inspection result

Reproduced>>GO TO 6.

Non-reproduced>>Start the diagnosis again. Follow the trouble diagnosis procedure when past error is detected.

## 6.CHECK UNIT REPRODUCTION

Perform the reproduction test as per the following procedure for each unit.

1. Turn the ignition switch OFF.
2. Disconnect the battery cable from the negative terminal.
3. Disconnect one of the unit connectors of CAN communication system.

### **NOTE:**

ECM and IPDM E/R have a termination circuit. Check other units first.

4. Connect the battery cable to the negative terminal. Check if the symptoms described in the "Symptom (Results from interview with customer)" are reproduced.

### **NOTE:**

Although unit-related error symptoms occur, do not confuse them with other symptoms.

## Inspection result

Reproduced>>Connect the connector. Check other units as per the above procedure.

Non-reproduced>>Replace the unit whose connector was disconnected.

A  
B  
C  
D  
E  
F  
G  
H  
I  
J  
K  
L

LAN

N  
O  
P

# MAIN LINE BETWEEN DLC AND HVAC CIRCUIT

< DTC/CIRCUIT DIAGNOSIS >

[CAN SYSTEM (TYPE 3)]

## DTC/CIRCUIT DIAGNOSIS

### MAIN LINE BETWEEN DLC AND HVAC CIRCUIT

#### Diagnosis Procedure

INFOID:000000008839116

#### 1. CHECK HARNESS CONTINUITY (OPEN CIRCUIT)

1. Turn the ignition switch OFF.
2. Disconnect the battery cable from the negative terminal.
3. Disconnect the following harness connectors.
  - ECM
  - A/C auto amp.
4. Check the continuity between the data link connector and the A/C auto amp. harness connector.

| Data link connector |              | A/C auto amp. harness connector |              | Continuity |
|---------------------|--------------|---------------------------------|--------------|------------|
| Connector No.       | Terminal No. | Connector No.                   | Terminal No. |            |
| M22                 | 6            | M37                             | 1            | Existed    |
|                     | 14           |                                 | 2            | Existed    |

#### Is the inspection result normal?

YES (Present error)>>Check CAN system type decision again.

YES (Past error)>>Error was detected in the main line between the data link connector and the A/C auto amp.

NO >> Repair the main line between the data link connector and the A/C auto amp.



# MAIN LINE BETWEEN HVAC AND A-BAG CIRCUIT

< DTC/CIRCUIT DIAGNOSIS >

[CAN SYSTEM (TYPE 3)]

## MAIN LINE BETWEEN HVAC AND A-BAG CIRCUIT

### Diagnosis Procedure

INFOID:000000008839118

#### 1. CHECK HARNESS CONTINUITY (OPEN CIRCUIT)

1. Turn the ignition switch OFF.
2. Disconnect the battery cable from the negative terminal.
3. Disconnect the following harness connectors.
  - A/C auto amp.
  - Harness connectors M1 and E30
4. Check the continuity between the harness connector and the A/C auto amp. harness connector.

| A/C auto amp. harness connector |              | Harness connector |              | Continuity |
|---------------------------------|--------------|-------------------|--------------|------------|
| Connector No.                   | Terminal No. | Connector No.     | Terminal No. |            |
| M37                             | 1            | M1                | 15G          | Existed    |
|                                 | 2            |                   | 8G           | Existed    |

#### Is the inspection result normal?

YES (Present error)>>Check CAN system type decision again.

YES (Past error)>>Error was detected in the main line between the A/C auto amp. and the air bag diagnosis sensor unit.

NO >> Repair the main line between the A/C auto amp. and the air bag diagnosis sensor unit.

A  
B  
C  
D  
E  
F  
G  
H  
I  
J  
K  
L  
N  
O  
P

LAN

# MAIN LINE BETWEEN A-BAG AND ABS CIRCUIT

< DTC/CIRCUIT DIAGNOSIS >

[CAN SYSTEM (TYPE 3)]

## MAIN LINE BETWEEN A-BAG AND ABS CIRCUIT

### Diagnosis Procedure

INFOID:000000008839119

#### 1.CHECK CONNECTOR

1. Turn the ignition switch OFF.
2. Disconnect the battery cable from the negative terminal.
3. Check the following terminals and connectors for damage, bend and loose connection (connector side and harness side).
  - Harness connector M1
  - Harness connector E30

Is the inspection result normal?

YES >> GO TO 2.

NO >> Repair the terminal and connector.

#### 2.CHECK HARNESS CONTINUITY (OPEN CIRCUIT)

1. Disconnect the following harness connectors.
  - A/C auto amp.
  - Harness connectors M1 and E30
2. Check the continuity between the A/C auto amp. harness connector and the harness connector.

| A/C auto amp. harness connector |              | Harness connector |              | Continuity |
|---------------------------------|--------------|-------------------|--------------|------------|
| Connector No.                   | Terminal No. | Connector No.     | Terminal No. |            |
| M37                             | 1            | M1                | 15G          | Existed    |
|                                 | 2            |                   | 8G           | Existed    |

Is the inspection result normal?

YES >> GO TO 3.

NO >> Repair the main line between the air bag diagnosis sensor unit and the harness connector M1.

#### 3.CHECK HARNESS CONTINUITY (OPEN CIRCUIT)

1. Disconnect the connector of ABS actuator and electric unit (control unit).
2. Check the continuity between the harness connector and the ABS actuator and electric unit (control unit) harness connector.

| Harness connector |              | ABS actuator and electric unit (control unit) harness connector |              | Continuity |
|-------------------|--------------|---|--------------|------------|
| Connector No.     | Terminal No. | Connector No.   | Terminal No. |            |
| E30               | 15G          | E26   | 26           | Existed    |
|                   | 8G           |   | 15           | Existed    |

Is the inspection result normal?

YES (Present error)>>Check CAN system type decision again.

YES (Past error)>>Error was detected in the main line between the air bag diagnosis sensor unit and the ABS actuator and electric unit (control unit).

NO >> Repair the main line between the harness connector E30 and the ABS actuator and electric unit (control unit).

# ECM BRANCH LINE CIRCUIT

< DTC/CIRCUIT DIAGNOSIS >

[CAN SYSTEM (TYPE 3)]

## ECM BRANCH LINE CIRCUIT

### Diagnosis Procedure

INFOID:000000008839120

#### 1. CHECK CONNECTOR

1. Turn the ignition switch OFF.
2. Disconnect the battery cable from the negative terminal.
3. Check the following terminals and connectors for damage, bend and loose connection (unit side and connector side).
  - Models without automatic drive positioner
    - ECM
    - Harness connector E30
    - Harness connector M1
  - Models with automatic drive positioner
    - ECM
    - Harness connector E29
    - Harness connector B10

Is the inspection result normal?

YES >> GO TO 2.

NO >> Repair the terminal and connector.

#### 2. CHECK HARNESS FOR OPEN CIRCUIT

1. Disconnect the connector of ECM.
2. Check the resistance between the ECM harness connector terminals.

| ECM harness connector |              | Resistance (Ω)    |
|-----------------------|--------------|-------------------|
| Connector No.         | Terminal No. |                   |
| E10                   | 98 97        | Approx. 108 – 132 |

Is the measurement value within the specification?

YES >> GO TO 3.

NO >> Repair the ECM branch line.

#### 3. CHECK POWER SUPPLY AND GROUND CIRCUIT

Check the power supply and the ground circuit of the ECM. Refer to [EC-155, "Diagnosis Procedure"](#).

Is the inspection result normal?

YES (Present error)>>Replace the ECM. Refer to [EC-17, "ADDITIONAL SERVICE WHEN REPLACING CONTROL UNIT : Description"](#).

YES (Past error)>>Error was detected in the ECM branch line.

NO >> Repair the power supply and the ground circuit.

LAN

# BCM BRANCH LINE CIRCUIT

< DTC/CIRCUIT DIAGNOSIS >

[CAN SYSTEM (TYPE 3)]

## BCM BRANCH LINE CIRCUIT

### Diagnosis Procedure

INFOID:000000008839122

#### 1.CHECK CONNECTOR

1. Turn the ignition switch OFF.
2. Disconnect the battery cable from the negative terminal.
3. Check the terminals and connectors of the BCM for damage, bend and loose connection (unit side and connector side).

Is the inspection result normal?

- YES >> GO TO 2.  
NO >> Repair the terminal and connector.

#### 2.CHECK HARNESS FOR OPEN CIRCUIT

1. Disconnect the connector of BCM.
2. Check the resistance between the BCM harness connector terminals.

| BCM harness connector |              |    | Resistance (Ω)  |
|-----------------------|--------------|----|-----------------|
| Connector No.         | Terminal No. |    |                 |
| M19                   | 79           | 78 | Approx. 54 – 66 |

Is the measurement value within the specification?

- YES >> GO TO 3.  
NO >> Repair the BCM branch line.

#### 3.CHECK POWER SUPPLY AND GROUND CIRCUIT

Check the power supply and the ground circuit of the BCM. Refer to [BCS-36. "Diagnosis Procedure"](#).

Is the inspection result normal?

- YES (Present error)>>Replace the BCM. Refer to [BCS-79. "Removal and Installation"](#).  
YES (Past error)>>Error was detected in the BCM branch line.  
NO >> Repair the power supply and the ground circuit.

# DLC BRANCH LINE CIRCUIT

< DTC/CIRCUIT DIAGNOSIS >

[CAN SYSTEM (TYPE 3)]

## DLC BRANCH LINE CIRCUIT

### Diagnosis Procedure

INFOID:000000008839123

#### 1.CHECK CONNECTOR

1. Turn the ignition switch OFF.
2. Disconnect the battery cable from the negative terminal.
3. Check the terminals and connectors of the data link connector for damage, bend and loose connection (connector side and harness side).

Is the inspection result normal?

- YES >> GO TO 2.  
NO >> Repair the terminal and connector.

#### 2.CHECK HARNESS FOR OPEN CIRCUIT

Check the resistance between the data link connector terminals.

| Data link connector |              |    | Resistance (Ω)  |
|---------------------|--------------|----|-----------------|
| Connector No.       | Terminal No. |    |                 |
| M22                 | 6            | 14 | Approx. 54 – 66 |

Is the measurement value within the specification?

- YES (Present error)>>Check CAN system type decision again.  
YES (Past error)>>Error was detected in the data link connector branch line circuit.  
NO >> Repair the data link connector branch line.

A  
B  
C  
D  
E  
F  
G  
H  
I  
J  
K  
L  
N  
O  
P

LAN

# M&A BRANCH LINE CIRCUIT

< DTC/CIRCUIT DIAGNOSIS >

[CAN SYSTEM (TYPE 3)]

## M&A BRANCH LINE CIRCUIT

### Diagnosis Procedure

INFOID:000000008839124

#### 1. CHECK CONNECTOR

1. Turn the ignition switch OFF.
2. Disconnect the battery cable from the negative terminal.
3. Check the terminals and connectors of the combination meter for damage, bend and loose connection (unit side and connector side).

Is the inspection result normal?

- YES >> GO TO 2.  
NO >> Repair the terminal and connector.

#### 2. CHECK HARNESS FOR OPEN CIRCUIT

1. Disconnect the connector of combination meter.
2. Check the resistance between the combination meter harness connector terminals.

| Combination meter harness connector |              |    | Resistance ( $\Omega$ ) |
|-------------------------------------|--------------|----|-------------------------|
| Connector No.                       | Terminal No. |    |                         |
| M24                                 | 21           | 22 | Approx. 54 – 66         |

Is the measurement value within the specification?

- YES >> GO TO 3.  
NO >> Repair the combination meter branch line.

#### 3. CHECK POWER SUPPLY AND GROUND CIRCUIT

Check the power supply and the ground circuit of the combination meter. Refer to [MWI-37, "COMBINATION METER : Diagnosis Procedure"](#).

Is the inspection result normal?

- YES (Present error)>>Replace the combination meter. Refer to [MWI-121, "Removal and Installation"](#).  
YES (Past error)>>Error was detected in the combination meter branch line.  
NO >> Repair the power supply and the ground circuit.

# AV BRANCH LINE CIRCUIT

< DTC/CIRCUIT DIAGNOSIS >

[CAN SYSTEM (TYPE 3)]

## AV BRANCH LINE CIRCUIT

### Diagnosis Procedure

INFOID:000000008839125

#### 1. CHECK CONNECTOR

1. Turn the ignition switch OFF.
2. Disconnect the battery cable from the negative terminal.
3. Check the terminals and connectors of the AV control unit for damage, bend and loose connection (unit side and connector side).

Is the inspection result normal?

- YES >> GO TO 2.  
NO >> Repair the terminal and connector.

#### 2. CHECK HARNESS FOR OPEN CIRCUIT

1. Disconnect the connector of AV control unit.
  2. Check the resistance between the AV control unit harness connector terminals.
- Models without navigation system

| AV control unit harness connector |              |    | Resistance (Ω)  |
|-----------------------------------|--------------|----|-----------------|
| Connector No.                     | Terminal No. |    |                 |
| M156                              | 86           | 87 | Approx. 54 – 66 |

- Models with navigation system

| AV control unit harness connector |              |    | Resistance (Ω)  |
|-----------------------------------|--------------|----|-----------------|
| Connector No.                     | Terminal No. |    |                 |
| M163                              | 62           | 46 | Approx. 54 – 66 |

Is the measurement value within the specification?

- YES >> GO TO 3.  
NO >> Repair the AV control unit branch line.

#### 3. CHECK POWER SUPPLY AND GROUND CIRCUIT

Check the power supply and the ground circuit of the AV control unit. Refer to the following.

- Models with BOSE audio with color display: [AV-240, "AV CONTROL UNIT : Diagnosis Procedure"](#)
- Models with BOSE audio with color display with navigation system: [AV-424, "AV CONTROL UNIT : Diagnosis Procedure"](#)

Is the inspection result normal?

- YES (Present error)>>Replace the AV control unit. Refer to the following.
- Models with BOSE audio with color display: [AV-334, "Removal and Installation"](#)
  - Models with BOSE audio with color display with navigation system: [AV-505, "Removal and Installation"](#)

YES (Past error)>>Error was detected in the AV control unit branch line.

- NO >> Repair the power supply and the ground circuit.

# HVAC BRANCH LINE CIRCUIT

< DTC/CIRCUIT DIAGNOSIS >

[CAN SYSTEM (TYPE 3)]

## HVAC BRANCH LINE CIRCUIT

### Diagnosis Procedure

INFOID:000000008839126

#### 1. CHECK CONNECTOR

1. Turn the ignition switch OFF.
2. Disconnect the battery cable from the negative terminal.
3. Check the terminals and connectors of the A/C auto amp. for damage, bend and loose connection (unit side and connector side).

Is the inspection result normal?

- YES >> GO TO 2.  
NO >> Repair the terminal and connector.

#### 2. CHECK HARNESS FOR OPEN CIRCUIT

1. Disconnect the connector of A/C auto amp.
2. Check the resistance between the A/C auto amp. harness connector terminals.

| A/C auto amp. harness connector |              |   | Resistance ( $\Omega$ ) |
|---------------------------------|--------------|---|-------------------------|
| Connector No.                   | Terminal No. |   |                         |
| M37                             | 1            | 2 | Approx. 54 – 66         |

Is the measurement value within the specification?

- YES >> GO TO 3.  
NO >> Repair the A/C auto amp. branch line.

#### 3. CHECK POWER SUPPLY AND GROUND CIRCUIT

Check the power supply and the ground circuit of the A/C auto amp. Refer to the following.

- Models with color display: [HAC-60, "A/C AUTO AMP. : Diagnosis Procedure"](#)
- Models with monochrome display: [HAC-164, "A/C AUTO AMP. : Diagnosis Procedure"](#)

Is the inspection result normal?

- YES (Present error)>>Replace the A/C auto amp. Refer to the following.
- Models with color display: [HAC-99, "Removal and Installation"](#)
  - Models monochrome display: [HAC-203, "Removal and Installation"](#)
- YES (Past error)>>Error was detected in the A/C auto amp. branch line.  
NO >> Repair the power supply and the ground circuit.



# STRG BRANCH LINE CIRCUIT

< DTC/CIRCUIT DIAGNOSIS >

[CAN SYSTEM (TYPE 3)]

## STRG BRANCH LINE CIRCUIT

### Diagnosis Procedure

INFOID:000000008839127

#### 1. CHECK CONNECTOR

1. Turn the ignition switch OFF.
2. Disconnect the battery cable from the negative terminal.
3. Check the terminals and connectors of the steering angle sensor for damage, bend and loose connection (unit side and connector side).

Is the inspection result normal?

- YES >> GO TO 2.  
NO >> Repair the terminal and connector.

#### 2. CHECK HARNESS FOR OPEN CIRCUIT

1. Disconnect the connector of steering angle sensor.
2. Check the resistance between the steering angle sensor harness connector terminals.

| Steering angle sensor harness connector |              |   | Resistance (Ω)  |
|---|--------------|---|-----------------|
| Connector No.                           | Terminal No. |   |                 |
| M53                                     | 5            | 2 | Approx. 54 – 66 |

Is the measurement value within the specification?

- YES >> GO TO 3.  
NO >> Repair the steering angle sensor branch line.

#### 3. CHECK POWER SUPPLY AND GROUND CIRCUIT

Check the power supply and the ground circuit of the steering angle sensor. Refer to [BRC-83, "Wiring Diagram"](#).

Is the inspection result normal?

- YES (Present error)>>Replace the steering angle sensor. Refer to [BRC-109, "Removal and Installation"](#).  
YES (Past error)>>Error was detected in the steering angle sensor branch line.  
NO >> Repair the power supply and the ground circuit.

A  
B  
C  
D  
E  
F  
G  
H  
I  
J  
K  
L

LAN

# A-BAG BRANCH LINE CIRCUIT

< DTC/CIRCUIT DIAGNOSIS >

[CAN SYSTEM (TYPE 3)]

## A-BAG BRANCH LINE CIRCUIT

### Diagnosis Procedure

INFOID:000000008839128

#### **WARNING:**

Always observe the following items for preventing accidental activation.

- Before servicing, turn ignition switch OFF, disconnect battery negative terminal, and wait 3 minutes or more. (To discharge backup capacitor.)
- Never use unspecified tester or other measuring device.

#### **1**.CHECK CONNECTOR

1. Turn the ignition switch OFF.
2. Disconnect the battery cable from the negative terminal.
3. Check the terminals and connectors of the air bag diagnosis sensor unit for damage, bend and loose connection (unit side and connector side).

Is the inspection result normal?

- YES >> GO TO 2.  
NO >> Replace the main harness.

#### **2**.CHECK AIR BAG DIAGNOSIS SENSOR UNIT

Check the air bag diagnosis sensor unit. Refer to [SRC-3. "Work Flow"](#).

Is the inspection result normal?

- YES >> Replace the main harness.  
NO >> Replace parts whose air bag system has a malfunction.

# ABS BRANCH LINE CIRCUIT

< DTC/CIRCUIT DIAGNOSIS >

[CAN SYSTEM (TYPE 3)]

## ABS BRANCH LINE CIRCUIT

### Diagnosis Procedure

INFOID:000000008839129

#### 1. CHECK CONNECTOR

1. Turn the ignition switch OFF.
2. Disconnect the battery cable from the negative terminal.
3. Check the terminals and connectors of the ABS actuator and electric unit (control unit) for damage, bend and loose connection (unit side and connector side).

Is the inspection result normal?

- YES >> GO TO 2.  
NO >> Repair the terminal and connector.

#### 2. CHECK HARNESS FOR OPEN CIRCUIT

1. Disconnect the connector of ABS actuator and electric unit (control unit).
2. Check the resistance between the ABS actuator and electric unit (control unit) harness connector terminals.

| ABS actuator and electric unit (control unit) harness connector |              |    | Resistance (Ω)  |
|---|--------------|----|-----------------|
| Connector No.   | Terminal No. |    |                 |
| E26   | 26           | 15 | Approx. 54 – 66 |

Is the measurement value within the specification?

- YES >> GO TO 3.  
NO >> Repair the ABS actuator and electric unit (control unit) branch line.

#### 3. CHECK POWER SUPPLY AND GROUND CIRCUIT

Check the power supply and the ground circuit of the ABS actuator and electric unit (control unit). Refer to [BRC-83, "Wiring Diagram"](#).

Is the inspection result normal?

- YES (Present error)>>Replace the ABS actuator and electric unit (control unit). Refer to [BRC-106, "Exploded View"](#).  
YES (Past error)>>Error was detected in the ABS actuator and electric unit (control unit) branch line.  
NO >> Repair the power supply and the ground circuit.

A  
B  
C  
D  
E  
F  
G  
H  
I  
J  
K  
L

LAN

# TCM BRANCH LINE CIRCUIT

< DTC/CIRCUIT DIAGNOSIS >

[CAN SYSTEM (TYPE 3)]

## TCM BRANCH LINE CIRCUIT

### Diagnosis Procedure

INFOID:000000008839130

#### 1. CHECK CONNECTOR

1. Turn the ignition switch OFF.
2. Disconnect the battery cable from the negative terminal.
3. Check the following terminals and connectors for damage, bend and loose connection (unit side and connector side).
  - TCM
  - Harness connector F1
  - Harness connector E3

Is the inspection result normal?

YES >> GO TO 2.

NO >> Repair the terminal and connector.

#### 2. CHECK HARNESS FOR OPEN CIRCUIT

1. Disconnect the connector of TCM.
2. Check the resistance between the TCM harness connector terminals.

| TCM harness connector |              |    | Resistance ( $\Omega$ ) |
|-----------------------|--------------|----|-------------------------|
| Connector No.         | Terminal No. |    |                         |
| F15                   | 32           | 31 | Approx. 54 – 66         |

Is the measurement value within the specification?

YES >> GO TO 3.

NO >> Repair the TCM branch line.

#### 3. CHECK POWER SUPPLY AND GROUND CIRCUIT

Check the power supply and the ground circuit of the TCM. Refer to [TM-124, "Wiring Diagram"](#).

Is the inspection result normal?

YES (Present error)>>Replace the TCM. Refer to [TM-166, "Exploded View"](#).

YES (Past error)>>Error was detected in the TCM branch line.

NO >> Repair the power supply and the ground circuit.

# IPDM-E BRANCH LINE CIRCUIT

< DTC/CIRCUIT DIAGNOSIS >

[CAN SYSTEM (TYPE 3)]

## IPDM-E BRANCH LINE CIRCUIT

### Diagnosis Procedure

INFOID:000000008839131

#### 1. CHECK CONNECTOR

1. Turn the ignition switch OFF.
2. Disconnect the battery cable from the negative terminal.
3. Check the terminals and connectors of the IPDM E/R for damage, bend and loose connection (unit side and connector side).

Is the inspection result normal?

- YES >> GO TO 2.  
NO >> Repair the terminal and connector.

#### 2. CHECK HARNESS FOR OPEN CIRCUIT

1. Disconnect the connector of IPDM E/R.
2. Check the resistance between the IPDM E/R harness connector terminals.

| IPDM E/R harness connector |              |    | Resistance ( $\Omega$ ) |
|----------------------------|--------------|----|-------------------------|
| Connector No.              | Terminal No. |    |                         |
| E17                        | 40           | 39 | Approx. 108 – 132       |

Is the measurement value within the specification?

- YES >> GO TO 3.  
NO >> Repair the IPDM E/R branch line.

#### 3. CHECK POWER SUPPLY AND GROUND CIRCUIT

Check the power supply and the ground circuit of the IPDM E/R. Refer to [PCS-18. "Diagnosis Procedure"](#).

Is the inspection result normal?

- YES (Present error)>>Replace the IPDM E/R. Refer to [PCS-35. "Removal and Installation"](#).  
YES (Past error)>>Error was detected in the IPDM E/R branch line.  
NO >> Repair the power supply and the ground circuit.

A  
B  
C  
D  
E  
F  
G  
H  
I  
J  
K  
L

LAN

# CAN COMMUNICATION CIRCUIT

< DTC/CIRCUIT DIAGNOSIS >

[CAN SYSTEM (TYPE 3)]

## CAN COMMUNICATION CIRCUIT

### Diagnosis Procedure

INFOID:000000008839132

#### 1. CONNECTOR INSPECTION

1. Turn the ignition switch OFF.
2. Disconnect the battery cable from the negative terminal.
3. Disconnect all the unit connectors on CAN communication system.
4. Check terminals and connectors for damage, bend and loose connection.

Is the inspection result normal?

- YES >> GO TO 2.  
NO >> Repair the terminal and connector.

#### 2. CHECK HARNESS CONTINUITY (SHORT CIRCUIT)

Check the continuity between the data link connector terminals.

| Data link connector |              |    | Continuity  |
|---------------------|--------------|----|-------------|
| Connector No.       | Terminal No. |    |             |
| M22                 | 6            | 14 | Not existed |

Is the inspection result normal?

- YES >> GO TO 3.  
NO >> Check the harness and repair the root cause.

#### 3. CHECK HARNESS CONTINUITY (SHORT CIRCUIT)

Check the continuity between the data link connector and the ground.

| Data link connector |              | Ground | Continuity  |
|---------------------|--------------|--------|-------------|
| Connector No.       | Terminal No. |        |             |
| M22                 | 6            |        | Not existed |
|                     | 14           |        | Not existed |

Is the inspection result normal?

- YES >> GO TO 4.  
NO >> Check the harness and repair the root cause.

#### 4. CHECK ECM AND IPDM E/R TERMINATION CIRCUIT

1. Remove the ECM and the IPDM E/R.
2. Check the resistance between the ECM terminals.

| ECM          |    | Resistance ( $\Omega$ ) |
|--------------|----|-------------------------|
| Terminal No. |    |                         |
| 98           | 97 | Approx. 108 – 132       |

3. Check the resistance between the IPDM E/R terminals.

| IPDM E/R     |    | Resistance ( $\Omega$ ) |
|--------------|----|-------------------------|
| Terminal No. |    |                         |
| 40           | 39 | Approx. 108 – 132       |

Is the measurement value within the specification?

- YES >> GO TO 5.  
NO >> Replace the ECM and/or the IPDM E/R.

#### 5. CHECK SYMPTOM

Connect all the connectors. Check if the symptoms described in the "Symptom (Results from interview with customer)" are reproduced.

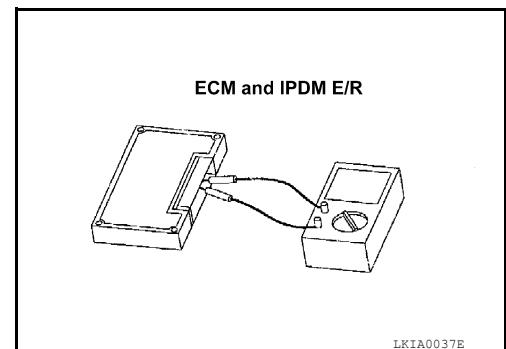

# CAN COMMUNICATION CIRCUIT

< DTC/CIRCUIT DIAGNOSIS >

[CAN SYSTEM (TYPE 3)]

## Inspection result

Reproduced>>GO TO 6.

Non-reproduced>>Start the diagnosis again. Follow the trouble diagnosis procedure when past error is detected.

## 6.CHECK UNIT REPRODUCTION

Perform the reproduction test as per the following procedure for each unit.

1. Turn the ignition switch OFF.
2. Disconnect the battery cable from the negative terminal.
3. Disconnect one of the unit connectors of CAN communication system.

### **NOTE:**

ECM and IPDM E/R have a termination circuit. Check other units first.

4. Connect the battery cable to the negative terminal. Check if the symptoms described in the "Symptom (Results from interview with customer)" are reproduced.

### **NOTE:**

Although unit-related error symptoms occur, do not confuse them with other symptoms.

## Inspection result

Reproduced>>Connect the connector. Check other units as per the above procedure.

Non-reproduced>>Replace the unit whose connector was disconnected.

A  
B  
C  
D  
E  
F  
G  
H  
I  
J  
K  
L

LAN

N  
O  
P

# MAIN LINE BETWEEN ADP AND DLC CIRCUIT

< DTC/CIRCUIT DIAGNOSIS >

[CAN SYSTEM (TYPE 4)]

## DTC/CIRCUIT DIAGNOSIS

### MAIN LINE BETWEEN ADP AND DLC CIRCUIT

#### Diagnosis Procedure

INFOID:000000008839137

#### 1. CHECK CONNECTOR

1. Turn the ignition switch OFF.
2. Disconnect the battery cable from the negative terminal.
3. Check the following terminals and connectors for damage, bend and loose connection (connector side and harness side).
  - Harness connector B1
  - Harness connector M6

Is the inspection result normal?

YES >> GO TO 2.

NO >> Repair the terminal and connector.

#### 2. CHECK HARNESS CONTINUITY (OPEN CIRCUIT)

1. Disconnect the following harness connectors.
  - Harness connectors B208 and B32
  - Harness connectors B1 and M6
2. Check the continuity between the harness connectors.

| Harness connector |              | Harness connector |              | Continuity |
|-------------------|--------------|-------------------|--------------|------------|
| Connector No.     | Terminal No. | Connector No.     | Terminal No. |            |
| B32               | 9            | B1                | 15J          | Existed    |
|                   | 10           |                   | 16J          | Existed    |

Is the inspection result normal?

YES >> GO TO 3.

NO >> Repair the main line between the harness connectors B32 and B1.

#### 3. CHECK HARNESS CONTINUITY (OPEN CIRCUIT)

Check the continuity between the harness connector and the data link connector.

| Harness connector |              | Data link connector |              | Continuity |
|-------------------|--------------|---------------------|--------------|------------|
| Connector No.     | Terminal No. | Connector No.       | Terminal No. |            |
| M6                | 15J          | M22                 | 6            | Existed    |
|                   | 16J          |                     | 14           | Existed    |

Is the inspection result normal?

YES (Present error)>>Check CAN system type decision again.

YES (Past error)>>Error was detected in the main line between the driver seat control unit and the data link connector.

NO >> Repair the main line between the harness connector M6 and the data link connector.



# MAIN LINE BETWEEN DLC AND HVAC CIRCUIT

< DTC/CIRCUIT DIAGNOSIS >

[CAN SYSTEM (TYPE 4)]

## MAIN LINE BETWEEN DLC AND HVAC CIRCUIT

### Diagnosis Procedure

INFOID:000000008839138

#### 1. CHECK HARNESS CONTINUITY (OPEN CIRCUIT)

1. Turn the ignition switch OFF.
2. Disconnect the battery cable from the negative terminal.
3. Disconnect the following harness connectors.
  - ECM
  - A/C auto amp.
4. Check the continuity between the data link connector and the A/C auto amp. harness connector.

| Data link connector |              | A/C auto amp. harness connector |              | Continuity |
|---------------------|--------------|---------------------------------|--------------|------------|
| Connector No.       | Terminal No. | Connector No.                   | Terminal No. |            |
| M22                 | 6            | M37                             | 1            | Existed    |
|                     | 14           |                                 | 2            | Existed    |

#### Is the inspection result normal?

YES (Present error)>>Check CAN system type decision again.

YES (Past error)>>Error was detected in the main line between the data link connector and the A/C auto amp.

NO >> Repair the main line between the data link connector and the A/C auto amp.

LAN

# MAIN LINE BETWEEN HVAC AND A-BAG CIRCUIT

< DTC/CIRCUIT DIAGNOSIS >

[CAN SYSTEM (TYPE 4)]

## MAIN LINE BETWEEN HVAC AND A-BAG CIRCUIT

### Diagnosis Procedure

INFOID:000000008839140

#### 1. CHECK HARNESS CONTINUITY (OPEN CIRCUIT)

1. Turn the ignition switch OFF.
2. Disconnect the battery cable from the negative terminal.
3. Disconnect the following harness connectors.
  - A/C auto amp.
  - Harness connectors M1 and E30
4. Check the continuity between the harness connector and the A/C auto amp. harness connector.

| A/C auto amp. harness connector |              | Harness connector |              | Continuity |
|---------------------------------|--------------|-------------------|--------------|------------|
| Connector No.                   | Terminal No. | Connector No.     | Terminal No. |            |
| M37                             | 1            | M1                | 15G          | Existed    |
|                                 | 2            |                   | 8G           | Existed    |

#### Is the inspection result normal?

YES (Present error)>>Check CAN system type decision again.

YES (Past error)>>Error was detected in the main line between the A/C auto amp. and the air bag diagnosis sensor unit.

NO >> Repair the main line between the A/C auto amp. and the air bag diagnosis sensor unit.

# MAIN LINE BETWEEN A-BAG AND ABS CIRCUIT

< DTC/CIRCUIT DIAGNOSIS >

[CAN SYSTEM (TYPE 4)]

## MAIN LINE BETWEEN A-BAG AND ABS CIRCUIT

### Diagnosis Procedure

INFOID:000000008839141

#### 1.CHECK CONNECTOR

1. Turn the ignition switch OFF.
2. Disconnect the battery cable from the negative terminal.
3. Check the following terminals and connectors for damage, bend and loose connection (connector side and harness side).
  - Harness connector M1
  - Harness connector E30

Is the inspection result normal?

YES >> GO TO 2.

NO >> Repair the terminal and connector.

#### 2.CHECK HARNESS CONTINUITY (OPEN CIRCUIT)

1. Disconnect the following harness connectors.
  - A/C auto amp.
  - Harness connectors M1 and E30
2. Check the continuity between the A/C auto amp. harness connector and the harness connector.

| A/C auto amp. harness connector |              | Harness connector |              | Continuity |
|---------------------------------|--------------|-------------------|--------------|------------|
| Connector No.                   | Terminal No. | Connector No.     | Terminal No. |            |
| M37                             | 1            | M1                | 15G          | Existed    |
|                                 | 2            |                   | 8G           | Existed    |

Is the inspection result normal?

YES >> GO TO 3.

NO >> Repair the main line between the air bag diagnosis sensor unit and the harness connector M1.

#### 3.CHECK HARNESS CONTINUITY (OPEN CIRCUIT)

1. Disconnect the connector of ABS actuator and electric unit (control unit).
2. Check the continuity between the harness connector and the ABS actuator and electric unit (control unit) harness connector.

| Harness connector |              | ABS actuator and electric unit (control unit) harness connector |              | Continuity |
|-------------------|--------------|---|--------------|------------|
| Connector No.     | Terminal No. | Connector No.   | Terminal No. |            |
| E30               | 15G          | E26   | 26           | Existed    |
|                   | 8G           |   | 15           | Existed    |

Is the inspection result normal?

YES (Present error)>>Check CAN system type decision again.

YES (Past error)>>Error was detected in the main line between the air bag diagnosis sensor unit and the ABS actuator and electric unit (control unit).

NO >> Repair the main line between the harness connector E30 and the ABS actuator and electric unit (control unit).

A  
B  
C  
D  
E  
F  
G  
H  
I  
J  
K  
L  
LAN  
N  
O  
P

# ECM BRANCH LINE CIRCUIT

< DTC/CIRCUIT DIAGNOSIS >

[CAN SYSTEM (TYPE 4)]

## ECM BRANCH LINE CIRCUIT

### Diagnosis Procedure

INFOID:000000008839142

#### 1. CHECK CONNECTOR

1. Turn the ignition switch OFF.
2. Disconnect the battery cable from the negative terminal.
3. Check the following terminals and connectors for damage, bend and loose connection (unit side and connector side).
  - Models without automatic drive positioner
    - ECM
    - Harness connector E30
    - Harness connector M1
  - Models with automatic drive positioner
    - ECM
    - Harness connector E29
    - Harness connector B10

Is the inspection result normal?

YES >> GO TO 2.

NO >> Repair the terminal and connector.

#### 2. CHECK HARNESS FOR OPEN CIRCUIT

1. Disconnect the connector of ECM.
2. Check the resistance between the ECM harness connector terminals.

| ECM harness connector |              | Resistance ( $\Omega$ ) |
|-----------------------|--------------|-------------------------|
| Connector No.         | Terminal No. |                         |
| E10                   | 98           | Approx. 108 – 132       |
|                       | 97           |                         |

Is the measurement value within the specification?

YES >> GO TO 3.

NO >> Repair the ECM branch line.

#### 3. CHECK POWER SUPPLY AND GROUND CIRCUIT

Check the power supply and the ground circuit of the ECM. Refer to [EC-155, "Diagnosis Procedure"](#).

Is the inspection result normal?

YES (Present error)>>Replace the ECM. Refer to [EC-17, "ADDITIONAL SERVICE WHEN REPLACING CONTROL UNIT : Description"](#).

YES (Past error)>>Error was detected in the ECM branch line.

NO >> Repair the power supply and the ground circuit.

# ADP BRANCH LINE CIRCUIT

< DTC/CIRCUIT DIAGNOSIS >

[CAN SYSTEM (TYPE 4)]

## ADP BRANCH LINE CIRCUIT

### Diagnosis Procedure

INFOID:000000008839143

#### 1. CHECK CONNECTOR

1. Turn the ignition switch OFF.
2. Disconnect the battery cable from the negative terminal.
3. Check the following terminals and connectors for damage, bend and loose connection (unit side and connector side).
  - Driver seat control unit
  - Harness connector B208
  - Harness connector B32

Is the inspection result normal?

YES >> GO TO 2.

NO >> Repair the terminal and connector.

#### 2. CHECK HARNESS FOR OPEN CIRCUIT

1. Disconnect the connector of driver seat control unit.
2. Check the resistance between the driver seat control unit harness connector terminals.

| Driver seat control unit harness connector |              |    | Resistance (Ω)  |
|--|--------------|----|-----------------|
| Connector No.                              | Terminal No. |    |                 |
| B203                                       | 16           | 32 | Approx. 54 – 66 |

Is the measurement value within the specification?

YES >> GO TO 3.

NO >> Repair the driver seat control unit branch line.

#### 3. CHECK POWER SUPPLY AND GROUND CIRCUIT

Check the power supply and the ground circuit of the driver seat control unit. Refer to [ADP-47, "DRIVER SEAT CONTROL UNIT : Diagnosis Procedure"](#).

Is the inspection result normal?

YES (Present error)>>Replace the driver seat control unit. Refer to [ADP-168, "Removal and Installation"](#).

YES (Past error)>>Error was detected in the driver seat control unit branch line.

NO >> Repair the power supply and the ground circuit.

A  
B  
C  
D  
E  
F  
G  
H  
I  
J  
K  
L

LAN

# BCM BRANCH LINE CIRCUIT

< DTC/CIRCUIT DIAGNOSIS >

[CAN SYSTEM (TYPE 4)]

## BCM BRANCH LINE CIRCUIT

### Diagnosis Procedure

INFOID:000000008839144

#### 1. CHECK CONNECTOR

1. Turn the ignition switch OFF.
2. Disconnect the battery cable from the negative terminal.
3. Check the terminals and connectors of the BCM for damage, bend and loose connection (unit side and connector side).

Is the inspection result normal?

- YES >> GO TO 2.  
NO >> Repair the terminal and connector.

#### 2. CHECK HARNESS FOR OPEN CIRCUIT

1. Disconnect the connector of BCM.
2. Check the resistance between the BCM harness connector terminals.

| BCM harness connector |              |    | Resistance (Ω)  |
|-----------------------|--------------|----|-----------------|
| Connector No.         | Terminal No. |    |                 |
| M19                   | 79           | 78 | Approx. 54 – 66 |

Is the measurement value within the specification?

- YES >> GO TO 3.  
NO >> Repair the BCM branch line.

#### 3. CHECK POWER SUPPLY AND GROUND CIRCUIT

Check the power supply and the ground circuit of the BCM. Refer to [BCS-36. "Diagnosis Procedure"](#).

Is the inspection result normal?

- YES (Present error)>>Replace the BCM. Refer to [BCS-79. "Removal and Installation"](#).  
YES (Past error)>>Error was detected in the BCM branch line.  
NO >> Repair the power supply and the ground circuit.

# DLC BRANCH LINE CIRCUIT

< DTC/CIRCUIT DIAGNOSIS >

[CAN SYSTEM (TYPE 4)]

## DLC BRANCH LINE CIRCUIT

### Diagnosis Procedure

INFOID:000000008839145

#### 1. CHECK CONNECTOR

1. Turn the ignition switch OFF.
2. Disconnect the battery cable from the negative terminal.
3. Check the terminals and connectors of the data link connector for damage, bend and loose connection (connector side and harness side).

Is the inspection result normal?

- YES >> GO TO 2.  
NO >> Repair the terminal and connector.

#### 2. CHECK HARNESS FOR OPEN CIRCUIT

Check the resistance between the data link connector terminals.

| Data link connector |              |    | Resistance (Ω)  |
|---------------------|--------------|----|-----------------|
| Connector No.       | Terminal No. |    |                 |
| M22                 | 6            | 14 | Approx. 54 – 66 |

Is the measurement value within the specification?

- YES (Present error)>>Check CAN system type decision again.  
YES (Past error)>>Error was detected in the data link connector branch line circuit.  
NO >> Repair the data link connector branch line.

A  
B  
C  
D  
E  
F  
G  
H  
I  
J  
K  
L

LAN

N  
O  
P

# M&A BRANCH LINE CIRCUIT

< DTC/CIRCUIT DIAGNOSIS >

[CAN SYSTEM (TYPE 4)]

## M&A BRANCH LINE CIRCUIT

### Diagnosis Procedure

INFOID:000000008839146

#### 1.CHECK CONNECTOR

1. Turn the ignition switch OFF.
2. Disconnect the battery cable from the negative terminal.
3. Check the terminals and connectors of the combination meter for damage, bend and loose connection (unit side and connector side).

Is the inspection result normal?

- YES >> GO TO 2.  
NO >> Repair the terminal and connector.

#### 2.CHECK HARNESS FOR OPEN CIRCUIT

1. Disconnect the connector of combination meter.
2. Check the resistance between the combination meter harness connector terminals.

| Combination meter harness connector |              |    | Resistance ( $\Omega$ ) |
|-------------------------------------|--------------|----|-------------------------|
| Connector No.                       | Terminal No. |    |                         |
| M24                                 | 21           | 22 | Approx. 54 – 66         |

Is the measurement value within the specification?

- YES >> GO TO 3.  
NO >> Repair the combination meter branch line.

#### 3.CHECK POWER SUPPLY AND GROUND CIRCUIT

Check the power supply and the ground circuit of the combination meter. Refer to [MWI-37, "COMBINATION METER : Diagnosis Procedure"](#).

Is the inspection result normal?

- YES (Present error)>>Replace the combination meter. Refer to [MWI-121, "Removal and Installation"](#).  
YES (Past error)>>Error was detected in the combination meter branch line.  
NO >> Repair the power supply and the ground circuit.



# AV BRANCH LINE CIRCUIT

< DTC/CIRCUIT DIAGNOSIS >

[CAN SYSTEM (TYPE 4)]

## AV BRANCH LINE CIRCUIT

### Diagnosis Procedure

INFOID:000000008839147

#### 1. CHECK CONNECTOR

1. Turn the ignition switch OFF.
2. Disconnect the battery cable from the negative terminal.
3. Check the terminals and connectors of the AV control unit for damage, bend and loose connection (unit side and connector side).

Is the inspection result normal?

- YES >> GO TO 2.  
NO >> Repair the terminal and connector.

#### 2. CHECK HARNESS FOR OPEN CIRCUIT

1. Disconnect the connector of AV control unit.
  2. Check the resistance between the AV control unit harness connector terminals.
- Models without navigation system

| AV control unit harness connector |              |    | Resistance (Ω)  |
|-----------------------------------|--------------|----|-----------------|
| Connector No.                     | Terminal No. |    |                 |
| M156                              | 86           | 87 | Approx. 54 – 66 |

- Models with navigation system

| AV control unit harness connector |              |    | Resistance (Ω)  |
|-----------------------------------|--------------|----|-----------------|
| Connector No.                     | Terminal No. |    |                 |
| M163                              | 62           | 46 | Approx. 54 – 66 |

Is the measurement value within the specification?

- YES >> GO TO 3.  
NO >> Repair the AV control unit branch line.

#### 3. CHECK POWER SUPPLY AND GROUND CIRCUIT

Check the power supply and the ground circuit of the AV control unit. Refer to the following.

- Models with BOSE audio with color display: [AV-240, "AV CONTROL UNIT : Diagnosis Procedure"](#)
- Models with BOSE audio with color display with navigation system: [AV-424, "AV CONTROL UNIT : Diagnosis Procedure"](#)

Is the inspection result normal?

- YES (Present error)>>Replace the AV control unit. Refer to the following.
- Models with BOSE audio with color display: [AV-334, "Removal and Installation"](#)
  - Models with BOSE audio with color display with navigation system: [AV-505, "Removal and Installation"](#)

YES (Past error)>>Error was detected in the AV control unit branch line.

- NO >> Repair the power supply and the ground circuit.

# HVAC BRANCH LINE CIRCUIT

< DTC/CIRCUIT DIAGNOSIS >

[CAN SYSTEM (TYPE 4)]

## HVAC BRANCH LINE CIRCUIT

### Diagnosis Procedure

INFOID:000000008839148

#### 1. CHECK CONNECTOR

1. Turn the ignition switch OFF.
2. Disconnect the battery cable from the negative terminal.
3. Check the terminals and connectors of the A/C auto amp. for damage, bend and loose connection (unit side and connector side).

Is the inspection result normal?

- YES >> GO TO 2.  
NO >> Repair the terminal and connector.

#### 2. CHECK HARNESS FOR OPEN CIRCUIT

1. Disconnect the connector of A/C auto amp.
2. Check the resistance between the A/C auto amp. harness connector terminals.

| A/C auto amp. harness connector |              |   | Resistance ( $\Omega$ ) |
|---------------------------------|--------------|---|-------------------------|
| Connector No.                   | Terminal No. |   |                         |
| M37                             | 1            | 2 | Approx. 54 – 66         |

Is the measurement value within the specification?

- YES >> GO TO 3.  
NO >> Repair the A/C auto amp. branch line.

#### 3. CHECK POWER SUPPLY AND GROUND CIRCUIT

Check the power supply and the ground circuit of the A/C auto amp. Refer to the following.

- Models with color display: [HAC-60, "A/C AUTO AMP. : Diagnosis Procedure"](#)
- Models with monochrome display: [HAC-164, "A/C AUTO AMP. : Diagnosis Procedure"](#)

Is the inspection result normal?

- YES (Present error)>>Replace the A/C auto amp. Refer to the following.
- Models with color display: [HAC-99, "Removal and Installation"](#)
  - Models monochrome display: [HAC-203, "Removal and Installation"](#)
- YES (Past error)>>Error was detected in the A/C auto amp. branch line.  
NO >> Repair the power supply and the ground circuit.

# STRG BRANCH LINE CIRCUIT

< DTC/CIRCUIT DIAGNOSIS >

[CAN SYSTEM (TYPE 4)]

## STRG BRANCH LINE CIRCUIT

### Diagnosis Procedure

INFOID:000000008839149

#### 1. CHECK CONNECTOR

1. Turn the ignition switch OFF.
2. Disconnect the battery cable from the negative terminal.
3. Check the terminals and connectors of the steering angle sensor for damage, bend and loose connection (unit side and connector side).

Is the inspection result normal?

- YES >> GO TO 2.  
NO >> Repair the terminal and connector.

#### 2. CHECK HARNESS FOR OPEN CIRCUIT

1. Disconnect the connector of steering angle sensor.
2. Check the resistance between the steering angle sensor harness connector terminals.

| Steering angle sensor harness connector |              |   | Resistance ( $\Omega$ ) |
|---|--------------|---|-------------------------|
| Connector No.                           | Terminal No. |   |                         |
| M53                                     | 5            | 2 | Approx. 54 – 66         |

Is the measurement value within the specification?

- YES >> GO TO 3.  
NO >> Repair the steering angle sensor branch line.

#### 3. CHECK POWER SUPPLY AND GROUND CIRCUIT

Check the power supply and the ground circuit of the steering angle sensor. Refer to [BRC-83, "Wiring Diagram"](#).

Is the inspection result normal?

- YES (Present error)>>Replace the steering angle sensor. Refer to [BRC-109, "Removal and Installation"](#).  
YES (Past error)>>Error was detected in the steering angle sensor branch line.  
NO >> Repair the power supply and the ground circuit.

A  
B  
C  
D  
E  
F  
G  
H  
I  
J  
K  
L

LAN

N  
O  
P

# A-BAG BRANCH LINE CIRCUIT

< DTC/CIRCUIT DIAGNOSIS >

[CAN SYSTEM (TYPE 4)]

## A-BAG BRANCH LINE CIRCUIT

### Diagnosis Procedure

INFOID:000000008839150

#### **WARNING:**

Always observe the following items for preventing accidental activation.

- Before servicing, turn ignition switch OFF, disconnect battery negative terminal, and wait 3 minutes or more. (To discharge backup capacitor.)
- Never use unspecified tester or other measuring device.

#### **1**.CHECK CONNECTOR

1. Turn the ignition switch OFF.
2. Disconnect the battery cable from the negative terminal.
3. Check the terminals and connectors of the air bag diagnosis sensor unit for damage, bend and loose connection (unit side and connector side).

Is the inspection result normal?

- YES >> GO TO 2.  
NO >> Replace the main harness.

#### **2**.CHECK AIR BAG DIAGNOSIS SENSOR UNIT

Check the air bag diagnosis sensor unit. Refer to [SRC-3. "Work Flow"](#).

Is the inspection result normal?

- YES >> Replace the main harness.  
NO >> Replace parts whose air bag system has a malfunction.

# ABS BRANCH LINE CIRCUIT

< DTC/CIRCUIT DIAGNOSIS >

[CAN SYSTEM (TYPE 4)]

## ABS BRANCH LINE CIRCUIT

### Diagnosis Procedure

INFOID:000000008839151

#### 1. CHECK CONNECTOR

1. Turn the ignition switch OFF.
2. Disconnect the battery cable from the negative terminal.
3. Check the terminals and connectors of the ABS actuator and electric unit (control unit) for damage, bend and loose connection (unit side and connector side).

Is the inspection result normal?

- YES >> GO TO 2.  
NO >> Repair the terminal and connector.

#### 2. CHECK HARNESS FOR OPEN CIRCUIT

1. Disconnect the connector of ABS actuator and electric unit (control unit).
2. Check the resistance between the ABS actuator and electric unit (control unit) harness connector terminals.

| ABS actuator and electric unit (control unit) harness connector |              |    | Resistance (Ω)  |
|---|--------------|----|-----------------|
| Connector No.   | Terminal No. |    |                 |
| E26   | 26           | 15 | Approx. 54 – 66 |

Is the measurement value within the specification?

- YES >> GO TO 3.  
NO >> Repair the ABS actuator and electric unit (control unit) branch line.

#### 3. CHECK POWER SUPPLY AND GROUND CIRCUIT

Check the power supply and the ground circuit of the ABS actuator and electric unit (control unit). Refer to [BRC-83, "Wiring Diagram"](#).

Is the inspection result normal?

- YES (Present error)>>Replace the ABS actuator and electric unit (control unit). Refer to [BRC-106, "Exploded View"](#).  
YES (Past error)>>Error was detected in the ABS actuator and electric unit (control unit) branch line.  
NO >> Repair the power supply and the ground circuit.

A  
B  
C  
D  
E  
F  
G  
H  
I  
J  
K  
L

LAN

# TCM BRANCH LINE CIRCUIT

< DTC/CIRCUIT DIAGNOSIS >

[CAN SYSTEM (TYPE 4)]

## TCM BRANCH LINE CIRCUIT

### Diagnosis Procedure

INFOID:000000008839152

#### 1. CHECK CONNECTOR

1. Turn the ignition switch OFF.
2. Disconnect the battery cable from the negative terminal.
3. Check the following terminals and connectors for damage, bend and loose connection (unit side and connector side).
  - TCM
  - Harness connector F1
  - Harness connector E3

Is the inspection result normal?

YES >> GO TO 2.

NO >> Repair the terminal and connector.

#### 2. CHECK HARNESS FOR OPEN CIRCUIT

1. Disconnect the connector of TCM.
2. Check the resistance between the TCM harness connector terminals.

| TCM harness connector |              |    | Resistance (Ω)  |
|-----------------------|--------------|----|-----------------|
| Connector No.         | Terminal No. |    |                 |
| F15                   | 32           | 31 | Approx. 54 – 66 |

Is the measurement value within the specification?

YES >> GO TO 3.

NO >> Repair the TCM branch line.

#### 3. CHECK POWER SUPPLY AND GROUND CIRCUIT

Check the power supply and the ground circuit of the TCM. Refer to [TM-124, "Wiring Diagram"](#).

Is the inspection result normal?

YES (Present error)>>Replace the TCM. Refer to [TM-166, "Exploded View"](#).

YES (Past error)>>Error was detected in the TCM branch line.

NO >> Repair the power supply and the ground circuit.

# IPDM-E BRANCH LINE CIRCUIT

< DTC/CIRCUIT DIAGNOSIS >

[CAN SYSTEM (TYPE 4)]

## IPDM-E BRANCH LINE CIRCUIT

### Diagnosis Procedure

INFOID:000000008839153

#### 1.CHECK CONNECTOR

1. Turn the ignition switch OFF.
2. Disconnect the battery cable from the negative terminal.
3. Check the terminals and connectors of the IPDM E/R for damage, bend and loose connection (unit side and connector side).

Is the inspection result normal?

- YES >> GO TO 2.  
NO >> Repair the terminal and connector.

#### 2.CHECK HARNESS FOR OPEN CIRCUIT

1. Disconnect the connector of IPDM E/R.
2. Check the resistance between the IPDM E/R harness connector terminals.

| IPDM E/R harness connector |              |    | Resistance (Ω)    |
|----------------------------|--------------|----|-------------------|
| Connector No.              | Terminal No. |    |                   |
| E17                        | 40           | 39 | Approx. 108 – 132 |

Is the measurement value within the specification?

- YES >> GO TO 3.  
NO >> Repair the IPDM E/R branch line.

#### 3.CHECK POWER SUPPLY AND GROUND CIRCUIT

Check the power supply and the ground circuit of the IPDM E/R. Refer to [PCS-18. "Diagnosis Procedure"](#).

Is the inspection result normal?

- YES (Present error)>>Replace the IPDM E/R. Refer to [PCS-35. "Removal and Installation"](#).  
YES (Past error)>>Error was detected in the IPDM E/R branch line.  
NO >> Repair the power supply and the ground circuit.

A  
B  
C  
D  
E  
F  
G  
H  
I  
J  
K  
L

LAN

# CAN COMMUNICATION CIRCUIT

< DTC/CIRCUIT DIAGNOSIS >

[CAN SYSTEM (TYPE 4)]

## CAN COMMUNICATION CIRCUIT

### Diagnosis Procedure

INFOID:000000008839154

#### 1. CONNECTOR INSPECTION

1. Turn the ignition switch OFF.
2. Disconnect the battery cable from the negative terminal.
3. Disconnect all the unit connectors on CAN communication system.
4. Check terminals and connectors for damage, bend and loose connection.

Is the inspection result normal?

- YES >> GO TO 2.  
NO >> Repair the terminal and connector.

#### 2. CHECK HARNESS CONTINUITY (SHORT CIRCUIT)

Check the continuity between the data link connector terminals.

| Data link connector |              |    | Continuity  |
|---------------------|--------------|----|-------------|
| Connector No.       | Terminal No. |    |             |
| M22                 | 6            | 14 | Not existed |

Is the inspection result normal?

- YES >> GO TO 3.  
NO >> Check the harness and repair the root cause.

#### 3. CHECK HARNESS CONTINUITY (SHORT CIRCUIT)

Check the continuity between the data link connector and the ground.

| Data link connector |              | Ground | Continuity  |
|---------------------|--------------|--------|-------------|
| Connector No.       | Terminal No. |        |             |
| M22                 | 6            |        | Not existed |
|                     | 14           |        | Not existed |

Is the inspection result normal?

- YES >> GO TO 4.  
NO >> Check the harness and repair the root cause.

#### 4. CHECK ECM AND IPDM E/R TERMINATION CIRCUIT

1. Remove the ECM and the IPDM E/R.
2. Check the resistance between the ECM terminals.

| ECM          |    | Resistance ( $\Omega$ ) |
|--------------|----|-------------------------|
| Terminal No. |    |                         |
| 98           | 97 | Approx. 108 – 132       |

3. Check the resistance between the IPDM E/R terminals.

| IPDM E/R     |    | Resistance ( $\Omega$ ) |
|--------------|----|-------------------------|
| Terminal No. |    |                         |
| 40           | 39 | Approx. 108 – 132       |

Is the measurement value within the specification?

- YES >> GO TO 5.  
NO >> Replace the ECM and/or the IPDM E/R.

#### 5. CHECK SYMPTOM

Connect all the connectors. Check if the symptoms described in the "Symptom (Results from interview with customer)" are reproduced.

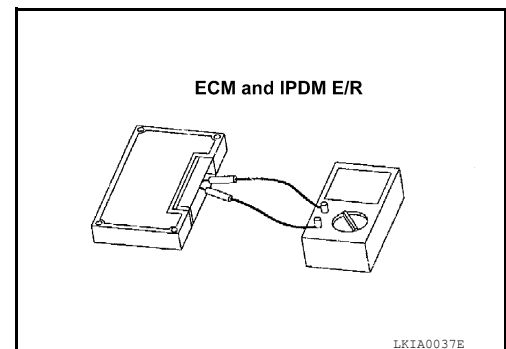



# CAN COMMUNICATION CIRCUIT

< DTC/CIRCUIT DIAGNOSIS >

[CAN SYSTEM (TYPE 4)]

## Inspection result

Reproduced>>GO TO 6.

Non-reproduced>>Start the diagnosis again. Follow the trouble diagnosis procedure when past error is detected.

## 6.CHECK UNIT REPRODUCTION

Perform the reproduction test as per the following procedure for each unit.

1. Turn the ignition switch OFF.
2. Disconnect the battery cable from the negative terminal.
3. Disconnect one of the unit connectors of CAN communication system.

### **NOTE:**

ECM and IPDM E/R have a termination circuit. Check other units first.

4. Connect the battery cable to the negative terminal. Check if the symptoms described in the "Symptom (Results from interview with customer)" are reproduced.

### **NOTE:**

Although unit-related error symptoms occur, do not confuse them with other symptoms.

## Inspection result

Reproduced>>Connect the connector. Check other units as per the above procedure.

Non-reproduced>>Replace the unit whose connector was disconnected.

A  
B  
C  
D  
E  
F  
G  
H  
I  
J  
K  
L

LAN

N  
O  
P

# MAIN LINE BETWEEN ADP AND DLC CIRCUIT

< DTC/CIRCUIT DIAGNOSIS >

[CAN SYSTEM (TYPE 5)]

## DTC/CIRCUIT DIAGNOSIS

### MAIN LINE BETWEEN ADP AND DLC CIRCUIT

#### Diagnosis Procedure

INFOID:000000008839159

#### 1. CHECK CONNECTOR

1. Turn the ignition switch OFF.
2. Disconnect the battery cable from the negative terminal.
3. Check the following terminals and connectors for damage, bend and loose connection (connector side and harness side).
  - Harness connector B1
  - Harness connector M6

Is the inspection result normal?

YES >> GO TO 2.

NO >> Repair the terminal and connector.

#### 2. CHECK HARNESS CONTINUITY (OPEN CIRCUIT)

1. Disconnect the following harness connectors.
  - Harness connectors B208 and B32
  - Harness connectors B1 and M6
2. Check the continuity between the harness connectors.

| Harness connector |              | Harness connector |              | Continuity |
|-------------------|--------------|-------------------|--------------|------------|
| Connector No.     | Terminal No. | Connector No.     | Terminal No. |            |
| B32               | 9            | B1                | 15J          | Existed    |
|                   | 10           |                   | 16J          | Existed    |

Is the inspection result normal?

YES >> GO TO 3.

NO >> Repair the main line between the harness connectors B32 and B1.

#### 3. CHECK HARNESS CONTINUITY (OPEN CIRCUIT)

Check the continuity between the harness connector and the data link connector.

| Harness connector |              | Data link connector |              | Continuity |
|-------------------|--------------|---------------------|--------------|------------|
| Connector No.     | Terminal No. | Connector No.       | Terminal No. |            |
| M6                | 15J          | M22                 | 6            | Existed    |
|                   | 16J          |                     | 14           | Existed    |

Is the inspection result normal?

YES (Present error)>>Check CAN system type decision again.

YES (Past error)>>Error was detected in the main line between the driver seat control unit and the data link connector.

NO >> Repair the main line between the harness connector M6 and the data link connector.

# MAIN LINE BETWEEN DLC AND HVAC CIRCUIT

< DTC/CIRCUIT DIAGNOSIS >

[CAN SYSTEM (TYPE 5)]

## MAIN LINE BETWEEN DLC AND HVAC CIRCUIT

### Diagnosis Procedure

INFOID:000000008839160

#### 1. CHECK HARNESS CONTINUITY (OPEN CIRCUIT)

1. Turn the ignition switch OFF.
2. Disconnect the battery cable from the negative terminal.
3. Disconnect the following harness connectors.
  - ECM
  - A/C auto amp.
4. Check the continuity between the data link connector and the A/C auto amp. harness connector.

| Data link connector |              | A/C auto amp. harness connector |              | Continuity |
|---------------------|--------------|---------------------------------|--------------|------------|
| Connector No.       | Terminal No. | Connector No.                   | Terminal No. |            |
| M22                 | 6            | M37                             | 1            | Existed    |
|                     | 14           |                                 | 2            | Existed    |

#### Is the inspection result normal?

YES (Present error)>>Check CAN system type decision again.

YES (Past error)>>Error was detected in the main line between the data link connector and the A/C auto amp.

NO >> Repair the main line between the data link connector and the A/C auto amp.

A  
B  
C  
D  
E  
F  
G  
H  
I  
J  
K  
L

LAN

N  
O  
P

# MAIN LINE BETWEEN HVAC AND ABS CIRCUIT

< DTC/CIRCUIT DIAGNOSIS >

[CAN SYSTEM (TYPE 5)]

## MAIN LINE BETWEEN HVAC AND ABS CIRCUIT

### Diagnosis Procedure

INFOID:000000008839161

#### 1. CHECK CONNECTOR

1. Turn the ignition switch OFF.
2. Disconnect the battery cable from the negative terminal.
3. Check the following terminals and connectors for damage, bend and loose connection (connector side and harness side).
  - Harness connector M1
  - Harness connector E30

Is the inspection result normal?

YES >> GO TO 2.

NO >> Repair the terminal and connector.

#### 2. CHECK HARNESS CONTINUITY (OPEN CIRCUIT)

1. Disconnect the following harness connectors.
  - A/C auto amp.
  - Harness connectors M1 and E30
2. Check the continuity between the A/C auto amp. harness connector and the harness connector.

| A/C auto amp. harness connector |              | Harness connector |              | Continuity |
|---------------------------------|--------------|-------------------|--------------|------------|
| Connector No.                   | Terminal No. | Connector No.     | Terminal No. |            |
| M37                             | 1            | M1                | 15G          | Existed    |
|                                 | 2            |                   | 8G           | Existed    |

Is the inspection result normal?

YES >> GO TO 3.

NO >> Repair the main line between the A/C auto amp. and the harness connector M1.

#### 3. CHECK HARNESS CONTINUITY (OPEN CIRCUIT)

1. Disconnect the connector of ABS actuator and electric unit (control unit).
2. Check the continuity between the harness connector and the ABS actuator and electric unit (control unit) harness connector.

| Harness connector |              | ABS actuator and electric unit (control unit) harness connector |              | Continuity |
|-------------------|--------------|---|--------------|------------|
| Connector No.     | Terminal No. | Connector No.   | Terminal No. |            |
| E30               | 15G          | E26   | 26           | Existed    |
|                   | 8G           |   | 15           | Existed    |

Is the inspection result normal?

YES (Present error)>>Check CAN system type decision again.

YES (Past error)>>Error was detected in the main line between the A/C auto amp. and the ABS actuator and electric unit (control unit).

NO >> Repair the main line between the harness connector E30 and the ABS actuator and electric unit (control unit).

# ECM BRANCH LINE CIRCUIT

< DTC/CIRCUIT DIAGNOSIS >

[CAN SYSTEM (TYPE 5)]

## ECM BRANCH LINE CIRCUIT

### Diagnosis Procedure

INFOID:000000008839164

#### 1. CHECK CONNECTOR

1. Turn the ignition switch OFF.
2. Disconnect the battery cable from the negative terminal.
3. Check the following terminals and connectors for damage, bend and loose connection (unit side and connector side).
  - Models without automatic drive positioner
    - ECM
    - Harness connector E30
    - Harness connector M1
  - Models with automatic drive positioner
    - ECM
    - Harness connector E29
    - Harness connector B10

Is the inspection result normal?

YES >> GO TO 2.

NO >> Repair the terminal and connector.

#### 2. CHECK HARNESS FOR OPEN CIRCUIT

1. Disconnect the connector of ECM.
2. Check the resistance between the ECM harness connector terminals.

| ECM harness connector |                            | Resistance (Ω)    |
|-----------------------|----------------------------|-------------------|
| Connector No.         | Terminal No.               |                   |
| E10                   | 98                      97 | Approx. 108 – 132 |

Is the measurement value within the specification?

YES >> GO TO 3.

NO >> Repair the ECM branch line.

#### 3. CHECK POWER SUPPLY AND GROUND CIRCUIT

Check the power supply and the ground circuit of the ECM. Refer to [EC-155, "Diagnosis Procedure"](#).

Is the inspection result normal?

YES (Present error)>>Replace the ECM. Refer to [EC-17, "ADDITIONAL SERVICE WHEN REPLACING CONTROL UNIT : Description"](#).

YES (Past error)>>Error was detected in the ECM branch line.

NO >> Repair the power supply and the ground circuit.

A  
B  
C  
D  
E  
F  
G  
H  
I  
J  
K  
L  
N  
O  
P

LAN

# ADP BRANCH LINE CIRCUIT

< DTC/CIRCUIT DIAGNOSIS >

[CAN SYSTEM (TYPE 5)]

## ADP BRANCH LINE CIRCUIT

### Diagnosis Procedure

INFOID:000000008839165

#### 1. CHECK CONNECTOR

1. Turn the ignition switch OFF.
2. Disconnect the battery cable from the negative terminal.
3. Check the following terminals and connectors for damage, bend and loose connection (unit side and connector side).
  - Driver seat control unit
  - Harness connector B208
  - Harness connector B32

Is the inspection result normal?

YES >> GO TO 2.

NO >> Repair the terminal and connector.

#### 2. CHECK HARNESS FOR OPEN CIRCUIT

1. Disconnect the connector of driver seat control unit.
2. Check the resistance between the driver seat control unit harness connector terminals.

| Driver seat control unit harness connector |              |    | Resistance (Ω)  |
|--|--------------|----|-----------------|
| Connector No.                              | Terminal No. |    |                 |
| B203                                       | 16           | 32 | Approx. 54 – 66 |

Is the measurement value within the specification?

YES >> GO TO 3.

NO >> Repair the driver seat control unit branch line.

#### 3. CHECK POWER SUPPLY AND GROUND CIRCUIT

Check the power supply and the ground circuit of the driver seat control unit. Refer to [ADP-47, "DRIVER SEAT CONTROL UNIT : Diagnosis Procedure"](#).

Is the inspection result normal?

YES (Present error)>>Replace the driver seat control unit. Refer to [ADP-168, "Removal and Installation"](#).

YES (Past error)>>Error was detected in the driver seat control unit branch line.

NO >> Repair the power supply and the ground circuit.

# BCM BRANCH LINE CIRCUIT

< DTC/CIRCUIT DIAGNOSIS >

[CAN SYSTEM (TYPE 5)]

## BCM BRANCH LINE CIRCUIT

### Diagnosis Procedure

INFOID:000000008839166

#### 1. CHECK CONNECTOR

1. Turn the ignition switch OFF.
2. Disconnect the battery cable from the negative terminal.
3. Check the terminals and connectors of the BCM for damage, bend and loose connection (unit side and connector side).

Is the inspection result normal?

- YES >> GO TO 2.  
NO >> Repair the terminal and connector.

#### 2. CHECK HARNESS FOR OPEN CIRCUIT

1. Disconnect the connector of BCM.
2. Check the resistance between the BCM harness connector terminals.

| BCM harness connector |              |    | Resistance (Ω)  |
|-----------------------|--------------|----|-----------------|
| Connector No.         | Terminal No. |    |                 |
| M19                   | 79           | 78 | Approx. 54 – 66 |

Is the measurement value within the specification?

- YES >> GO TO 3.  
NO >> Repair the BCM branch line.

#### 3. CHECK POWER SUPPLY AND GROUND CIRCUIT

Check the power supply and the ground circuit of the BCM. Refer to [BCS-36, "Diagnosis Procedure"](#).

Is the inspection result normal?

- YES (Present error)>>Replace the BCM. Refer to [BCS-79, "Removal and Installation"](#).  
YES (Past error)>>Error was detected in the BCM branch line.  
NO >> Repair the power supply and the ground circuit.

A  
B  
C  
D  
E  
F  
G  
H  
I  
J  
K  
L  
N  
O  
P

LAN

# DLC BRANCH LINE CIRCUIT

< DTC/CIRCUIT DIAGNOSIS >

[CAN SYSTEM (TYPE 5)]

## DLC BRANCH LINE CIRCUIT

### Diagnosis Procedure

INFOID:000000008839167

#### 1. CHECK CONNECTOR

1. Turn the ignition switch OFF.
2. Disconnect the battery cable from the negative terminal.
3. Check the terminals and connectors of the data link connector for damage, bend and loose connection (connector side and harness side).

Is the inspection result normal?

- YES >> GO TO 2.  
NO >> Repair the terminal and connector.

#### 2. CHECK HARNESS FOR OPEN CIRCUIT

Check the resistance between the data link connector terminals.

| Data link connector |              |    | Resistance ( $\Omega$ ) |
|---------------------|--------------|----|-------------------------|
| Connector No.       | Terminal No. |    |                         |
| M22                 | 6            | 14 | Approx. 54 – 66         |

Is the measurement value within the specification?

- YES (Present error)>>Check CAN system type decision again.  
YES (Past error)>>Error was detected in the data link connector branch line circuit.  
NO >> Repair the data link connector branch line.



M&A BRANCH LINE CIRCUIT

Diagnosis Procedure

INFOID:000000008839168

1.CHECK CONNECTOR

1. Turn the ignition switch OFF.
2. Disconnect the battery cable from the negative terminal.
3. Check the terminals and connectors of the combination meter for damage, bend and loose connection (unit side and connector side).

Is the inspection result normal?

- YES >> GO TO 2.  
 NO >> Repair the terminal and connector.

2.CHECK HARNESS FOR OPEN CIRCUIT

1. Disconnect the connector of combination meter.
2. Check the resistance between the combination meter harness connector terminals.

| Combination meter harness connector |                            | Resistance (Ω)  |
|-------------------------------------|----------------------------|-----------------|
| Connector No.                       | Terminal No.               |                 |
| M24                                 | 21                      22 | Approx. 54 – 66 |

Is the measurement value within the specification?

- YES >> GO TO 3.  
 NO >> Repair the combination meter branch line.

3.CHECK POWER SUPPLY AND GROUND CIRCUIT

Check the power supply and the ground circuit of the combination meter. Refer to [MWI-37, "COMBINATION METER : Diagnosis Procedure"](#).

Is the inspection result normal?

- YES (Present error)>>Replace the combination meter. Refer to [MWI-121, "Removal and Installation"](#).  
 YES (Past error)>>Error was detected in the combination meter branch line.  
 NO >> Repair the power supply and the ground circuit.

A  
B  
C  
D  
E  
F  
G  
H  
I  
J  
K  
L

LAN

N  
O  
P

## AV BRANCH LINE CIRCUIT

### Diagnosis Procedure

INFOID:000000008839169

#### 1. CHECK CONNECTOR

1. Turn the ignition switch OFF.
2. Disconnect the battery cable from the negative terminal.
3. Check the terminals and connectors of the AV control unit for damage, bend and loose connection (unit side and connector side).

Is the inspection result normal?

- YES >> GO TO 2.  
 NO >> Repair the terminal and connector.

#### 2. CHECK HARNESS FOR OPEN CIRCUIT

1. Disconnect the connector of AV control unit.
  2. Check the resistance between the AV control unit harness connector terminals.
- Models without navigation system

| AV control unit harness connector |              |    | Resistance (Ω)  |
|-----------------------------------|--------------|----|-----------------|
| Connector No.                     | Terminal No. |    |                 |
| M156                              | 86           | 87 | Approx. 54 – 66 |

- Models with navigation system

| AV control unit harness connector |              |    | Resistance (Ω)  |
|-----------------------------------|--------------|----|-----------------|
| Connector No.                     | Terminal No. |    |                 |
| M163                              | 62           | 46 | Approx. 54 – 66 |

Is the measurement value within the specification?

- YES >> GO TO 3.  
 NO >> Repair the AV control unit branch line.

#### 3. CHECK POWER SUPPLY AND GROUND CIRCUIT

Check the power supply and the ground circuit of the AV control unit. Refer to the following.

- Models with BOSE audio with color display: [AV-240, "AV CONTROL UNIT : Diagnosis Procedure"](#)
- Models with BOSE audio with color display with navigation system: [AV-424, "AV CONTROL UNIT : Diagnosis Procedure"](#)

Is the inspection result normal?

- YES (Present error)>>Replace the AV control unit. Refer to the following.
- Models with BOSE audio with color display: [AV-334, "Removal and Installation"](#)
  - Models with BOSE audio with color display with navigation system: [AV-505, "Removal and Installation"](#)

YES (Past error)>>Error was detected in the AV control unit branch line.

- NO >> Repair the power supply and the ground circuit.

# HVAC BRANCH LINE CIRCUIT

< DTC/CIRCUIT DIAGNOSIS >

[CAN SYSTEM (TYPE 5)]

## HVAC BRANCH LINE CIRCUIT

### Diagnosis Procedure

INFOID:000000008839170

#### 1. CHECK CONNECTOR

1. Turn the ignition switch OFF.
2. Disconnect the battery cable from the negative terminal.
3. Check the terminals and connectors of the A/C auto amp. for damage, bend and loose connection (unit side and connector side).

Is the inspection result normal?

- YES >> GO TO 2.  
NO >> Repair the terminal and connector.

#### 2. CHECK HARNESS FOR OPEN CIRCUIT

1. Disconnect the connector of A/C auto amp.
2. Check the resistance between the A/C auto amp. harness connector terminals.

| A/C auto amp. harness connector |              |   | Resistance (Ω)  |
|---------------------------------|--------------|---|-----------------|
| Connector No.                   | Terminal No. |   |                 |
| M37                             | 1            | 2 | Approx. 54 – 66 |

Is the measurement value within the specification?

- YES >> GO TO 3.  
NO >> Repair the A/C auto amp. branch line.

#### 3. CHECK POWER SUPPLY AND GROUND CIRCUIT

Check the power supply and the ground circuit of the A/C auto amp. Refer to the following.

- Models with color display: [HAC-60, "A/C AUTO AMP. : Diagnosis Procedure"](#)
- Models with monochrome display: [HAC-164, "A/C AUTO AMP. : Diagnosis Procedure"](#)

Is the inspection result normal?

- YES (Present error)>>Replace the A/C auto amp. Refer to the following.
- Models with color display: [HAC-99, "Removal and Installation"](#)
  - Models monochrome display: [HAC-203, "Removal and Installation"](#)

YES (Past error)>>Error was detected in the A/C auto amp. branch line.

NO >> Repair the power supply and the ground circuit.

A  
B  
C  
D  
E  
F  
G  
H  
I  
J  
K  
L

LAN

N  
O  
P

# STRG BRANCH LINE CIRCUIT

< DTC/CIRCUIT DIAGNOSIS >

[CAN SYSTEM (TYPE 5)]

## STRG BRANCH LINE CIRCUIT

### Diagnosis Procedure

INFOID:000000008839171

#### 1. CHECK CONNECTOR

1. Turn the ignition switch OFF.
2. Disconnect the battery cable from the negative terminal.
3. Check the terminals and connectors of the steering angle sensor for damage, bend and loose connection (unit side and connector side).

Is the inspection result normal?

- YES >> GO TO 2.  
NO >> Repair the terminal and connector.

#### 2. CHECK HARNESS FOR OPEN CIRCUIT

1. Disconnect the connector of steering angle sensor.
2. Check the resistance between the steering angle sensor harness connector terminals.

| Steering angle sensor harness connector |              |   | Resistance ( $\Omega$ ) |
|---|--------------|---|-------------------------|
| Connector No.                           | Terminal No. |   |                         |
| M53                                     | 5            | 2 | Approx. 54 – 66         |

Is the measurement value within the specification?

- YES >> GO TO 3.  
NO >> Repair the steering angle sensor branch line.

#### 3. CHECK POWER SUPPLY AND GROUND CIRCUIT

Check the power supply and the ground circuit of the steering angle sensor. Refer to [BRC-83, "Wiring Diagram"](#).

Is the inspection result normal?

- YES (Present error)>>Replace the steering angle sensor. Refer to [BRC-109, "Removal and Installation"](#).  
YES (Past error)>>Error was detected in the steering angle sensor branch line.  
NO >> Repair the power supply and the ground circuit.

# ABS BRANCH LINE CIRCUIT

< DTC/CIRCUIT DIAGNOSIS >

[CAN SYSTEM (TYPE 5)]

## ABS BRANCH LINE CIRCUIT

### Diagnosis Procedure

INFOID:000000008839173

#### 1. CHECK CONNECTOR

1. Turn the ignition switch OFF.
2. Disconnect the battery cable from the negative terminal.
3. Check the terminals and connectors of the ABS actuator and electric unit (control unit) for damage, bend and loose connection (unit side and connector side).

Is the inspection result normal?

- YES >> GO TO 2.  
NO >> Repair the terminal and connector.

#### 2. CHECK HARNESS FOR OPEN CIRCUIT

1. Disconnect the connector of ABS actuator and electric unit (control unit).
2. Check the resistance between the ABS actuator and electric unit (control unit) harness connector terminals.

| ABS actuator and electric unit (control unit) harness connector |              |    | Resistance (Ω)  |
|---|--------------|----|-----------------|
| Connector No.   | Terminal No. |    |                 |
| E26   | 26           | 15 | Approx. 54 – 66 |

Is the measurement value within the specification?

- YES >> GO TO 3.  
NO >> Repair the ABS actuator and electric unit (control unit) branch line.

#### 3. CHECK POWER SUPPLY AND GROUND CIRCUIT

Check the power supply and the ground circuit of the ABS actuator and electric unit (control unit). Refer to [BRC-83, "Wiring Diagram"](#).

Is the inspection result normal?

- YES (Present error)>>Replace the ABS actuator and electric unit (control unit). Refer to [BRC-106, "Exploded View"](#).  
YES (Past error)>>Error was detected in the ABS actuator and electric unit (control unit) branch line.  
NO >> Repair the power supply and the ground circuit.

A  
B  
C  
D  
E  
F  
G  
H  
I  
J  
K  
L

LAN

# TCM BRANCH LINE CIRCUIT

< DTC/CIRCUIT DIAGNOSIS >

[CAN SYSTEM (TYPE 5)]

## TCM BRANCH LINE CIRCUIT

### Diagnosis Procedure

INFOID:000000008839174

#### 1. CHECK CONNECTOR

1. Turn the ignition switch OFF.
2. Disconnect the battery cable from the negative terminal.
3. Check the following terminals and connectors for damage, bend and loose connection (unit side and connector side).
  - TCM
  - Harness connector F1
  - Harness connector E3

Is the inspection result normal?

YES >> GO TO 2.

NO >> Repair the terminal and connector.

#### 2. CHECK HARNESS FOR OPEN CIRCUIT

1. Disconnect the connector of TCM.
2. Check the resistance between the TCM harness connector terminals.

| TCM harness connector |              |    | Resistance (Ω)  |
|-----------------------|--------------|----|-----------------|
| Connector No.         | Terminal No. |    |                 |
| F15                   | 32           | 31 | Approx. 54 – 66 |

Is the measurement value within the specification?

YES >> GO TO 3.

NO >> Repair the TCM branch line.

#### 3. CHECK POWER SUPPLY AND GROUND CIRCUIT

Check the power supply and the ground circuit of the TCM. Refer to [TM-124, "Wiring Diagram"](#).

Is the inspection result normal?

YES (Present error)>>Replace the TCM. Refer to [TM-166, "Exploded View"](#).

YES (Past error)>>Error was detected in the TCM branch line.

NO >> Repair the power supply and the ground circuit.

# IPDM-E BRANCH LINE CIRCUIT

< DTC/CIRCUIT DIAGNOSIS >

[CAN SYSTEM (TYPE 5)]

## IPDM-E BRANCH LINE CIRCUIT

### Diagnosis Procedure

INFOID:000000008839175

#### 1. CHECK CONNECTOR

1. Turn the ignition switch OFF.
2. Disconnect the battery cable from the negative terminal.
3. Check the terminals and connectors of the IPDM E/R for damage, bend and loose connection (unit side and connector side).

Is the inspection result normal?

- YES >> GO TO 2.  
NO >> Repair the terminal and connector.

#### 2. CHECK HARNESS FOR OPEN CIRCUIT

1. Disconnect the connector of IPDM E/R.
2. Check the resistance between the IPDM E/R harness connector terminals.

| IPDM E/R harness connector |              |    | Resistance ( $\Omega$ ) |
|----------------------------|--------------|----|-------------------------|
| Connector No.              | Terminal No. |    |                         |
| E17                        | 40           | 39 | Approx. 108 – 132       |

Is the measurement value within the specification?

- YES >> GO TO 3.  
NO >> Repair the IPDM E/R branch line.

#### 3. CHECK POWER SUPPLY AND GROUND CIRCUIT

Check the power supply and the ground circuit of the IPDM E/R. Refer to [PCS-18. "Diagnosis Procedure"](#).

Is the inspection result normal?

- YES (Present error)>>Replace the IPDM E/R. Refer to [PCS-35. "Removal and Installation"](#).  
YES (Past error)>>Error was detected in the IPDM E/R branch line.  
NO >> Repair the power supply and the ground circuit.

A  
B  
C  
D  
E  
F  
G  
H  
I  
J  
K  
L

LAN

# CAN COMMUNICATION CIRCUIT

< DTC/CIRCUIT DIAGNOSIS >

[CAN SYSTEM (TYPE 5)]

## CAN COMMUNICATION CIRCUIT

### Diagnosis Procedure

INFOID:000000008839176

#### 1. CONNECTOR INSPECTION

1. Turn the ignition switch OFF.
2. Disconnect the battery cable from the negative terminal.
3. Disconnect all the unit connectors on CAN communication system.
4. Check terminals and connectors for damage, bend and loose connection.

Is the inspection result normal?

- YES >> GO TO 2.  
NO >> Repair the terminal and connector.

#### 2. CHECK HARNESS CONTINUITY (SHORT CIRCUIT)

Check the continuity between the data link connector terminals.

| Data link connector |              | Continuity  |
|---------------------|--------------|-------------|
| Connector No.       | Terminal No. |             |
| M22                 | 6 14         | Not existed |

Is the inspection result normal?

- YES >> GO TO 3.  
NO >> Check the harness and repair the root cause.

#### 3. CHECK HARNESS CONTINUITY (SHORT CIRCUIT)

Check the continuity between the data link connector and the ground.

| Data link connector |              | Ground | Continuity  |
|---------------------|--------------|--------|-------------|
| Connector No.       | Terminal No. |        |             |
| M22                 | 6            |        | Not existed |
|                     | 14           |        | Not existed |

Is the inspection result normal?

- YES >> GO TO 4.  
NO >> Check the harness and repair the root cause.

#### 4. CHECK ECM AND IPDM E/R TERMINATION CIRCUIT

1. Remove the ECM and the IPDM E/R.
2. Check the resistance between the ECM terminals.

| ECM          |    | Resistance ( $\Omega$ ) |
|--------------|----|-------------------------|
| Terminal No. |    |                         |
| 98           | 97 | Approx. 108 – 132       |

3. Check the resistance between the IPDM E/R terminals.

| IPDM E/R     |    | Resistance ( $\Omega$ ) |
|--------------|----|-------------------------|
| Terminal No. |    |                         |
| 40           | 39 | Approx. 108 – 132       |

Is the measurement value within the specification?

- YES >> GO TO 5.  
NO >> Replace the ECM and/or the IPDM E/R.

#### 5. CHECK SYMPTOM

Connect all the connectors. Check if the symptoms described in the "Symptom (Results from interview with customer)" are reproduced.

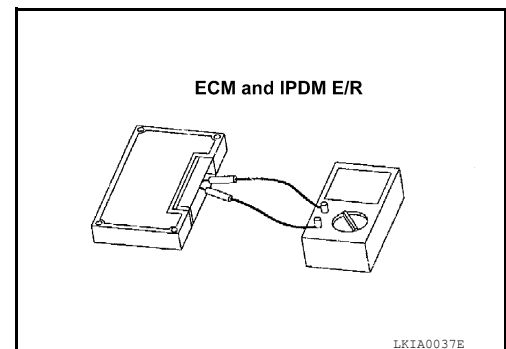



# CAN COMMUNICATION CIRCUIT

< DTC/CIRCUIT DIAGNOSIS >

[CAN SYSTEM (TYPE 5)]

## Inspection result

Reproduced>>GO TO 6.

Non-reproduced>>Start the diagnosis again. Follow the trouble diagnosis procedure when past error is detected.

## 6.CHECK UNIT REPRODUCTION

Perform the reproduction test as per the following procedure for each unit.

1. Turn the ignition switch OFF.
2. Disconnect the battery cable from the negative terminal.
3. Disconnect one of the unit connectors of CAN communication system.

### **NOTE:**

ECM and IPDM E/R have a termination circuit. Check other units first.

4. Connect the battery cable to the negative terminal. Check if the symptoms described in the "Symptom (Results from interview with customer)" are reproduced.

### **NOTE:**

Although unit-related error symptoms occur, do not confuse them with other symptoms.

## Inspection result

Reproduced>>Connect the connector. Check other units as per the above procedure.

Non-reproduced>>Replace the unit whose connector was disconnected.

A  
B  
C  
D  
E  
F  
G  
H  
I  
J  
K  
L

LAN

N  
O  
P